



# **Cisco Unified IP Phone 7961G/7961G-GE and 7941G/7941G-GE for Cisco Unified CallManager 5.1 (SCCP and SIP)**

**INCLUDING LICENSE AND WARRANTY**





## **Corporate Headquarters**

Cisco Systems, Inc.  
170 West Tasman Drive  
San Jose, CA 95134-1706  
USA  
<http://www.cisco.com>  
Tel: 408 526-4000  
800 553-NETS (6387)  
Fax: 408 526-4100





## Common Phone Tasks

View online help on the phone	Press  .
Place a call	Go-off hook before or after dialing a number.
Redial a number	Press <b>Redial</b> . Or press the Navigation button while on-hook to see your Placed Calls log.
Switch to the handset during a call	Pick up the handset.
Switch to the speaker or headset during a call	Press  or  , then hang up the handset.
Mute your phone	Press  .
Use your call logs	Press  to choose a call log. To dial, highlight a listing and go off-hook.
Edit a number	Press <b>EditDial</b> , << or >>.
Hold/resume a call	Press <b>Hold</b> or <b>Resume</b> .
Transfer a call to a new number	Press <b>Transfer</b> , enter the number, then press <b>Transfer</b> again.
Start a standard (ad hoc) conference call	Press <b>more</b> > <b>Confrn</b> , dial the participant, then press <b>Confrn</b> again.



Copyright © 2006 Cisco Systems, Inc. All rights reserved. Cisco, Cisco IOS, Cisco Systems, and the Cisco Systems logo are registered trademarks of Cisco Systems, Inc. or its affiliates in the United States and certain other countries. All other trademarks mentioned in this document or Website are the property of their respective owners. The use of the word partner does not imply a partnership relationship between Cisco and any other company. (0502R)

OL-11526-01



## Cisco Unified IP Phone 7961G/7961G-GE and 7941G/7941G-GE for Cisco Unified CallManager 5.1 (SCCP and SIP)

Softkey Definitions  
Phone Screen Icons  
Button Icons  
Common Phone Tasks







## Softkey Definitions

<b>AbbrDial</b>	Dial using a speed dial index number
<b>Answer</b>	Answer a call
<b>Back</b>	Return to the previous Help topic
<b>Barge</b>	Add yourself to a call on a shared line
<b>CallBack</b>	Receive notification when a busy extension becomes available
<b>Cancel</b>	Cancel an action or exit a screen without applying changes
<b>cBarge</b>	Add yourself to a call on a shared line and establish a conference
<b>CFwdALL</b>	Set up/cancel call forwarding
<b>Clear</b>	Delete records or settings
<b>Close</b>	Close the current window
<b>Conflist</b>	View conference participants
<b>Confrn</b>	Create a conference call
<b>Delete</b>	Remove characters to the right of the cursor when using EditDial
<b>Details</b>	Open the Details record for a multiparty call in the Missed Calls and Received Calls logs
<b>Dial</b>	Dial a phone number
<b>DirTrfr</b>	Transfer two calls to each other
<b>DND</b>	Turn off Do Not Disturb (DND)
<b>EditDial</b>	Edit a number in a call log
<b>EndCall</b>	Disconnect the current call
<b>Erase</b>	Reset settings to their defaults
<b>Exit</b>	Return to the previous screen
<b>GPickUp</b>	Answer a call ringing in another group



iDivert	Send a call to a voice messaging system
Join	Join several calls already on a single line to create a conference
Links	View related Help topics
Main	Display the Help main menu
MeetMe	Host a Meet-Me conference call
more	Display additional softkeys
NewCall	Make a new call
OPickUp	Answer a call ringing in an associated group
Park	Store a call using Call Park
PickUp	Answer a call in your group
QRT	Submit call problems to the system administrator
Redial	Redial the most recently dialed number
Remove	Remove a conference participant
Resume	Resume a call on hold
RmLstC	Drop the last party added to a conference call
Save	Save the chosen settings
Search	Search for a directory listing
Select	Select a menu item or call
Transfer	Transfer a call
Update	Refresh content
VidMode	Choose a video display mode
<<	Delete entered characters
>>	Move through entered characters

## Phone Screen Icons



### Line and Call State

	Call Forwarding enabled
	Call on hold
	Connected call
	Incoming call
	Off-hook
	On-hook
	Shared line in use





### Secure Calls





	Authenticated call
	Encrypted call

### Selected Device









	Handset in use
	Headset in use
	Speakerphone in use

### Other Features

	Busy line in a speed-dial, call log, or directory listing (BLF feature)
	Idle line in speed-dial, call log, or directory listing (BLF feature)
	Speed-dial, call log, or directory listing (line status unknown)
	Message waiting

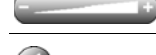
	Video enabled
	Option selected
	Feature enabled
	Phone service URL assigned
	URL entry in a call log is ready to edit

## Button Icons

	Messages
	Services
	Help
	Directories
	Settings
	Volume
	Speaker
	Mute
	Headset



# Contents

---

## **Getting Started 1**

- Using this Guide 1
- Finding Additional Information 2
- Safety and Performance Information 2
- Accessibility Features 4

## **Connecting Your Phone 5**

### **An Overview of Your Phone 8**

- Understanding Buttons and Hardware 8
- Understanding Phone Screen Features 12
  - Cleaning the Phone Screen 12
- Understanding Feature Buttons and Menus 13
  - Understanding the Help System on Your Phone 13
- Understanding Lines vs. Calls 14
  - Understanding Line and Call Icons 14
- Recognizing Recording Tones 15
- Understanding Feature Availability 15
- Understanding SIP vs. SCCP 15

### **Basic Call Handling 16**

- Placing a Call—Basic Options 16
- Placing a Call—Additional Options 17
- Answering a Call 18
- Ending a Call 19
- Using Hold and Resume 19
- Using Mute 20
- Switching Between Multiple Calls 20

Viewing Multiple Calls	20
Transferring Calls	21
Sending a Call to a Voice Messaging System	22
Forwarding All Calls to Another Number	23
Using Do Not Disturb	24
Making Conference Calls	25
Understanding Types of Conference Calls	25
Starting and Joining a Standard Conference	26
Starting or Joining a Meet-Me Conference Call	28

## **Advanced Call Handling 29**

Speed Dialing	29
Picking Up a Redirected Call on Your Phone	30
Using a Shared Line	31
Understanding Shared Lines	31
Adding Yourself to a Shared-Line Call	32
Preventing Others from Viewing or Barging a Shared-Line Call	33
Storing and Retrieving Parked Calls	33
Making and Receiving Secure Calls	34
Tracing Suspicious Calls	34
Prioritizing Critical Calls	35
Using Cisco Extension Mobility	36
Using BLF to Determine a Line State	36

## **Using a Handset, Headset, and Speakerphone 37**

Obtaining a Headset	38
Using AutoAnswer	38

## **Using Phone Settings 39**

Customizing Rings and Message Indicators	39
Customizing the Phone Screen	40

## **Using Call Logs and Directories 41**

Using Call Logs	41
-----------------	----

Directory Dialing	43
Using Corporate Directory on Your Phone	44
Using Personal Directory on Your Phone	45

## **Accessing Voice Messages 48**

### **Customizing Your Phone on the Web 49**

Accessing Your User Options Web Pages	49
Configuring Features and Services on the Web	50
Using Personal Directory on the Web	50
Using Your Personal Address Book on the Web	50
Configuring Fast Dials on the Web	51
Using the Address Book Synchronization Tool	52
Setting Up Speed Dials on the Web	52
Setting Up Phone Services on the Web	53
Controlling User Settings on the Web	54
Controlling Line Settings on the Web	55
Using Cisco WebDialer	57

## **Understanding Additional Configuration Options 59**

### **Troubleshooting Your Phone 61**

General Troubleshooting	61
Viewing Phone Administration Data	62
Using the Quality Reporting Tool	62

## **Cisco One-Year Limited Hardware Warranty Terms 63**

## **Index 65**







# Getting Started

---

## Using this Guide

This guide provides you with an overview of the features available on your phone. You can read it completely for a solid understanding of your phone's capabilities, or refer to the table below for pointers to commonly used sections.

<b>If you want to...</b>	<b>Then...</b>
Explore your phone on your own	Press  on the phone when you need assistance.
Review safety information	See <a href="#">Safety and Performance Information</a> , page 2.
Connect your phone	See <a href="#">Connecting Your Phone</a> , page 5.
Use your phone after it is installed	Start with <a href="#">An Overview of Your Phone</a> , page 8.
Learn what the button lights mean	See <a href="#">Understanding Buttons and Hardware</a> , page 8.
Learn about the display	See <a href="#">Understanding Phone Screen Features</a> , page 12.
Make calls	See <a href="#">Placing a Call—Basic Options</a> , page 16.
Put calls on hold	See <a href="#">Using Hold and Resume</a> , page 19.
Mute calls	See <a href="#">Using Mute</a> , page 20.
Transfer calls	See <a href="#">Transferring Calls</a> , page 21.
Make conference calls	See <a href="#">Making Conference Calls</a> , page 25.
Set up speed dialing	See <a href="#">Speed Dialing</a> , page 29.
Share a phone number	See <a href="#">Using a Shared Line</a> , page 31.
Use your phone as a speakerphone	See <a href="#">Using a Handset, Headset, and Speakerphone</a> , page 37.
Change the ring volume or tone	See <a href="#">Using Phone Settings</a> , page 39.
View your missed calls	See <a href="#">Using Call Logs and Directories</a> , page 41.
Listen to your voice messages	See <a href="#">Accessing Voice Messages</a> , page 48.
See softkey and icon definitions	See the Quick Reference Card in the front of this guide.

## Finding Additional Information

You can access the most current Cisco Unified IP Phone documentation on the World Wide Web at this URL:

[http://www.cisco.com/univercd/cc/td/doc/product/voice/c\\_ipphon/index.htm](http://www.cisco.com/univercd/cc/td/doc/product/voice/c_ipphon/index.htm)

You can access the Cisco website at this URL:

<http://www.cisco.com/>

International Cisco websites can be accessed from this URL:

[http://www.cisco.com/public/countries\\_languages.shtml](http://www.cisco.com/public/countries_languages.shtml)

## Safety and Performance Information

Read the following safety notices before installing or using your Cisco Unified IP Phone:



**Warning**

---

### **IMPORTANT SAFETY INSTRUCTIONS**

**This warning symbol means danger. You are in a situation that could cause bodily injury. Before you work on any equipment, be aware of the hazards involved with electrical circuitry and be familiar with standard practices for preventing accidents. Use the statement number provided at the end of each warning to locate its translation in the translated safety warnings that accompanied this device.** Statement 1071

---

### **SAVE THESE INSTRUCTIONS**



**Warning**

---

**Read the installation instructions before you connect the system to its power source.**

---



**Warning**

---

**Ultimate disposal of this product should be handled according to all national laws and regulations.**

---



**Warning**

---

**Do not work on the system or connect or disconnect cables during periods of lightning activity.**

---

**Warning**

---

**To avoid electric shock, do not connect safety extra low voltage (SELV) circuits to telephone network voltage (TNV) circuits. LAN ports contain SELV circuits, and WAN ports contain TNV circuits. Some LAN and WAN ports use RJ-45 connectors. Use caution when connecting cables.**

---

**Caution**

---

Inline power circuits provide current through the communication cable. Use the Cisco provided cable or a minimum 24 AWG communication cable.

---

## Using an External Power Supply

The following warnings apply when you use the external power supply with the Cisco Unified IP Phone:

**Warning**

---

**This product relies on the building's installation for short-circuit (over current) protection. Ensure that a fuse or circuit breaker no larger than 120 VAC, 15A U.S. (240 VAC, 10A international) is used on the phase conductors (all current-carrying conductors).**

---

**Warning**

---

**The device is designed to work with TN power systems.**

---

**Warning**

---

**The plug-socket combination must be accessible at all times because it serves as the main disconnecting device.**

---

**Warning**

---

**The power supply must be placed indoors.**

---

**Caution**

---

Only use the Cisco specified power supply with this product.

---

## Power Outage

Your accessibility to emergency service through the phone is dependent on the phone being powered. If there is an interruption in the power supply, Service and Emergency Calling Service dialing will not function until power is restored. In the case of a power failure or disruption, you may need to reset or reconfigure equipment before using the Service or Emergency Calling Service dialing.

## Using External Devices

The following information applies when you use external devices with the Cisco Unified IP Phone:

Cisco recommends the use of good quality external devices (such as headsets) that are shielded against unwanted radio frequency (RF) and audio frequency (AF) signals.

Depending on the quality of these devices and their proximity to other devices such as mobile phones or two-way radios, some audio noise may still occur. In these cases, Cisco recommends that you take one or more of the following actions:

- Move the external device away from the source of the RF or AF signals.
- Route the external device cables away from the source of the RF or AF signals.
- Use shielded cables for the external device, or use cables with a better shield and connector.
- Shorten the length of the external device cable.
- Apply ferrites or other such devices on the cables for the external device.

Cisco cannot guarantee the performance of the system because Cisco has no control over the quality of external devices, cables, and connectors. The system will perform adequately when suitable devices are attached using good quality cables and connectors.



---

### Caution

In European Union countries, use only external speakers, microphones, and headsets that are fully compliant with the EMC Directive [89/336/EC].

---

## Accessibility Features

A list of accessibility features is available upon request.

# Connecting Your Phone

Your system administrator will likely connect your new Cisco Unified IP Phone to the corporate IP telephony network. If that is not the case, refer to the figure and table below to connect your phone.

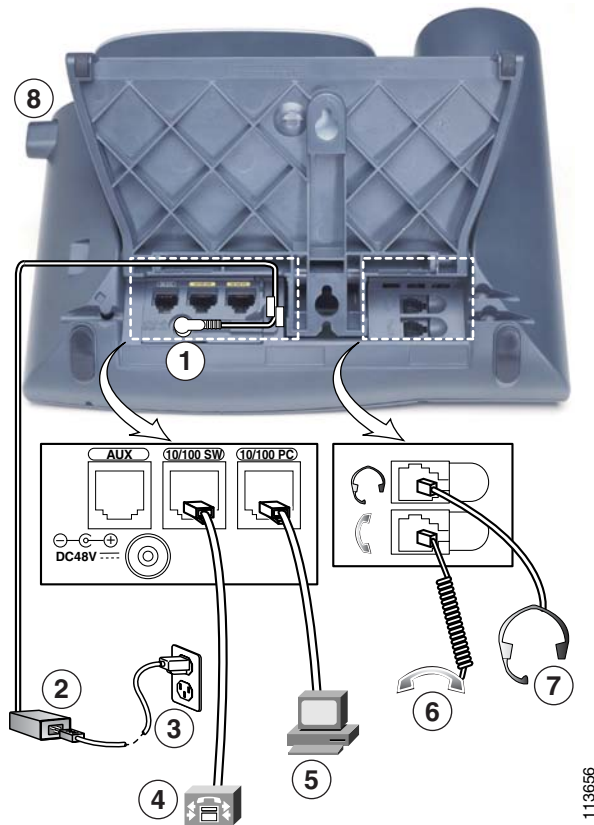

1	DC adaptor port (DC48V)	5	Access port (10/100 <sup>1</sup> PC)
2	AC-to-DC power supply	6	Handset port
3	AC power cord	7	Headset port
4	Network port (10/100 <sup>1</sup> SW)	8	Footstand button

1. Your phone may show 10/100/1000.

## Adjusting the Footstand

To change the angle of the phone base, adjust the footstand while pressing the footstand button.

## Adjusting the Handset Rest

Cisco recommends adjusting the handset rest, particularly when wall mounting the phone, as this will ensure that the receiver will not readily slip out of the cradle. See the table below for instructions.

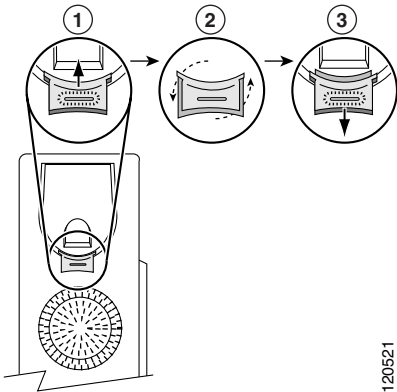

1	Set the handset aside and pull the square plastic tab from the handset rest.
2	Rotate the tab 180 degrees.
3	Slide the tab back into the handset rest. An extension protrudes from the top of the rotated tab. Return the handset to the handset rest.

## Registering with TAPS

After your phone is connected to the network, your system administrator might ask you to auto-register your phone using TAPS (Tool for Auto-Registered Phones Support). TAPS might be used for a new phone or to replace an existing phone.

To register with TAPS, pick up the handset, enter the TAPS extension provided by your system administrator, and follow the voice prompts. You might need to enter your entire extension, including the area code. After your phone displays a confirmation message, hang up. The phone will re-start.

## Headset Information

To use a headset, connect it to the headset port on the back of your phone.

Although Cisco Systems performs some internal testing of third-party headsets for use with the Cisco Unified IP Phones, Cisco does not certify or support products from headset or handset vendors. Because of the inherent environmental and hardware inconsistencies in the locations where Cisco Unified IP Phones are deployed, there is not a single “best” solution that is optimal for all environments. Cisco recommends that customers test the headsets that work best in their environment before deploying a large number of units in their network.

In some instances, the mechanics or electronics of various headsets can cause remote parties to hear an echo of their own voice when they speak to Cisco Unified IP Phone users.

Cisco Systems recommends the use of good quality external devices, like headsets that are screened against unwanted radio frequency (RF) and audio frequency (AF) signals. Depending on the quality of these devices and their proximity to other devices such as cell phones and two-way radios, some audio noise may still occur. See the “[Using External Devices](#)” section on page 4, for more information.

The primary reason that a particular headset would be inappropriate for the Cisco Unified IP Phone is the potential for an audible hum. This hum can be heard by either the remote party or by both the remote party and you, the Cisco Unified IP Phone user. Some potential humming or buzzing sounds can be caused by a range of outside sources, for example, electric lights, being near electric motors, large PC monitors. In some cases, a hum experienced by a user may be reduced or eliminated by using a local power cube or power injector. See the “[Using an External Power Supply](#)” section on page 3, for more information.

### Audio Quality Subjective to the User

Beyond the physical, mechanical and technical performance, the audio portion of a headset must sound good to you (the user) and to the party on the far end. Sound is subjective and Cisco cannot guarantee the performance of any headsets or handsets, but some of the headsets and handsets on the sites listed below have been reported to perform well on Cisco Unified IP Phones.

Nevertheless, it is ultimately still the customer's responsibility to test this equipment in their own environment to determine suitable performance.

For information about headsets, see:

<http://www.vxicorp.com/cisco>

<http://www.plantronics.com>

# An Overview of Your Phone

---

The Cisco Unified IP Phone 7961G and 7961G-GE (gigabit Ethernet version) and the 7941G and 7941G-GE (gigabit Ethernet version) are full-feature telephones that provide voice communication over the same data network that your personal computer uses, allowing you to place and receive phone calls, put calls on hold, speed dial numbers, transfer calls, make conference calls, and so on.

The gigabit Ethernet Cisco Unified IP Phone 7961G-GE and 7941G-GE deliver the latest technology and advancements in Gigabit Ethernet VoIP telephony, providing gigabit throughput to your desktop.

In addition to basic call-handling features, your phone can provide enhanced productivity features that extend your call-handling capabilities. Depending on configuration, your phone supports:

- Access to network data, XML applications, and web-based services.
- Online customizing of phone features and services from your User Options web pages.
- A comprehensive online help system that displays information on the phone screen.

## Understanding Buttons and Hardware

You can use [Figure 1](#) and [Figure 2](#) to identify buttons and hardware on your phone.



**Figure 1 Cisco Unified IP Phone 7961G and 7961G-GE**



















137503

**Figure 2 Cisco Unified IP Phone 7941G and 7941G-GE**



137504



	Item	Description	For more information, see...
1	Programmable buttons 	Depending on configuration, programmable buttons provide access to: <ul style="list-style-type: none"> <li>• Phone lines (line buttons)</li> <li>• Speed-dial numbers (speed-dial buttons, including the BLF speed-dial feature)</li> <li>• Web-based services (for example, a Personal Address Book (PAB) button)</li> <li>• Phone features (for example, a Privacy button)</li> </ul> The buttons illuminate to indicate status: <ul style="list-style-type: none"> <li> Green, steady—Active call</li> <li> Green, flashing—Held call</li> <li> Amber, steady—Privacy in use</li> <li> Amber, flashing—Incoming call</li> <li> Red, steady—Remote line in use (shared line or BLF status)</li> </ul>	<ul style="list-style-type: none"> <li>• <a href="#">Understanding Phone Screen Features, page 12</a></li> <li>• <a href="#">Basic Call Handling, page 16</a></li> <li>• <a href="#">Speed Dialing, page 29</a></li> <li>• <a href="#">Using a Shared Line, page 31</a></li> <li>• <a href="#">Using BLF to Determine a Line State, page 36</a></li> </ul>
2	Phone screen	Shows phone features.	<a href="#">Understanding Phone Screen Features, page 12</a>
3	Footstand button	Allows you to adjust the angle of the phone base.	<a href="#">Adjusting the Footstand, page 6</a>
4	Messages button 	Auto-dials your voice message service (varies by service).	<a href="#">Accessing Voice Messages, page 48</a>
5	Directories button 	Opens/closes the Directories menu. Use it to access call logs and directories.	<a href="#">Using Call Logs, page 41</a>
6	Help button 	Activates the Help menu.	<a href="#">Understanding the Help System on Your Phone, page 13</a>
7	Settings button 	Opens/closes the Settings menu. Use it to control phone screen contrast and ring sounds.	<a href="#">Using Phone Settings, page 39</a>
8	Services button 	Opens/closes the Services menu.	<a href="#">Customizing Your Phone on the Web, page 49</a>

	Item	Description	For more information, see...
9	Volume button 	Controls the handset, headset, and speakerphone volume (off-hook) and the ringer volume (on-hook).	<a href="#">Using a Handset, Headset, and Speakerphone, page 37</a>
10	Speaker button 	Toggles the speakerphone on or off. When the speakerphone is on, the button is lit.	<a href="#">Using a Handset, Headset, and Speakerphone, page 37</a>
11	Mute button 	Toggles the Mute feature on or off. When Mute is on, the button is lit.	<a href="#">Using Mute, page 20</a>
12	Headset button 	Toggles the headset on or off. When the headset is on, the button is lit.	<a href="#">Using a Handset, Headset, and Speakerphone, page 37</a>
13	Navigation button 	Allows you to scroll through menus and highlight items. When the phone is on-hook, displays phone numbers from your Placed Calls log.	<a href="#">Using Call Logs, page 41</a>
14	Keypad	Allows you to dial phone numbers, enter letters, and choose menu items.	<a href="#">Basic Call Handling, page 16</a>
15	Softkey buttons 	Each activates a softkey option (displayed on your phone screen).	<a href="#">Understanding Phone Screen Features, page 12</a>
16	Handset light strip	Indicates an incoming call or new voice message.	<a href="#">Accessing Voice Messages, page 48</a>

# Understanding Phone Screen Features

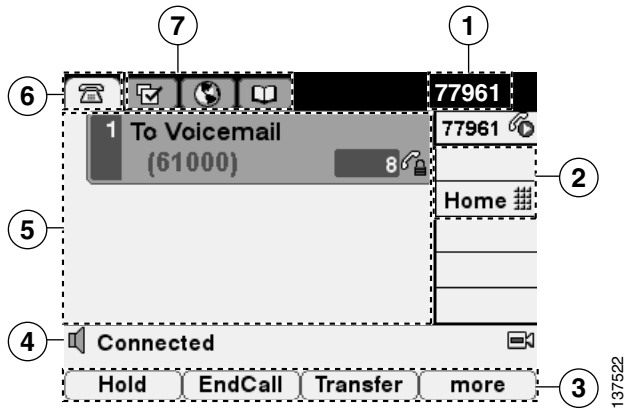
This is what your main phone screen might look like with active calls and several feature menus open:







1	Primary phone line	Displays the phone number (directory number) for your primary phone line. When several feature tabs are open, the phone number and the time and date alternate display in this area.
2	Programmable button indicators	Programmable buttons  can serve as phone line buttons, speed-dial buttons, phone service buttons or phone feature buttons. Icons and labels indicate how these buttons are configured. For an icon reference, see “ <a href="#">Phone Screen Icons</a> ” in the Quick Reference Card at the front of this guide.
3	Softkey labels	Each displays a softkey function. To activate a softkey, press the softkey button  .
4	Status line	Displays audio mode icons, status information, and prompts.
5	Call activity area	Displays current calls per line, including caller ID, call duration, and call state for the highlighted line (standard view). See “ <a href="#">Understanding Line and Call Icons</a> ” section on page 14, and <a href="#">Viewing Multiple Calls</a> , page 20.
6	Phone tab	Indicates call activity. Press this tab to return to the call activity area, if needed.
7	Feature tabs	Each indicates an open feature menu. See <a href="#">Understanding Feature Buttons and Menus</a> , page 13.

## Cleaning the Phone Screen

Use only a soft, dry cloth to wipe the phone screen. Do not use any liquids or powders on the phone, as they can contaminate phone components and cause failures.







## Understanding Feature Buttons and Menus

Press a feature button to open or close a feature menu.

If you want to...	Then...
Open or close a feature menu	Press a feature button:  Messages  Services  Directories  Settings  Help
Scroll through a list or menu	Press the <b>Navigation</b> button.
Go back one level in a feature menu	Press <b>Exit</b> . Pressing Exit from the top level of a menu, closes the menu.
Switch among open feature menus	Press a feature tab. Each feature menu has a corresponding tab. The tab is visible when the feature menu is open.

## Understanding the Help System on Your Phone

Your phone provides a comprehensive online help system. Help topics appear on the phone screen.

If you want to...	Then...
View the main menu	Press  on your phone and wait a few seconds for the menu to display. Main menu topics include: <ul style="list-style-type: none"> <li>• About Your Cisco Unified IP Phone—Details about your phone</li> <li>• How do I...?—Procedures for common phone tasks</li> <li>• Calling Features—Descriptions and procedures for calling features</li> <li>• Help—Tips on using and accessing Help</li> </ul>
Learn about a button or softkey	Press  , then quickly press a button or softkey.
Learn about a menu item	Press  ,  , or  to display a feature menu. Highlight a menu item, then press  twice quickly.
Get help using Help	Press  twice quickly. Select the help topic you need.

# Understanding Lines vs. Calls











To avoid confusion about lines and calls, refer to these descriptions:

**Lines**—Each line corresponds to a directory number that others can use to call you. The Cisco Unified IP Phone 7961G/7961G-GE supports one to six lines and the Cisco Unified IP Phone 7941G/7941G-GE supports one to two lines, depending on configuration. To see how many lines you have, look at the right side of your phone screen. You have as many lines as you have directory numbers and phone line icons: .

**Calls**—Each line can support multiple calls. By default, your phone supports four connected calls per line, but your system administrator can adjust this number according to your needs. Only one call can be active at any time; other calls are automatically placed on hold.

## Understanding Line and Call Icons

Your phone displays icons to help you determine the call and line state.

Icon	Line or Call State	Description
	On-hook line	No call activity on this line.
	Off-hook line	You are dialing a number or an outgoing call is ringing.
	Connected call	You are currently connected to the other party.
	Ringing call	An incoming call is ringing on one of your lines.
	Call on hold	You have put the call on hold. See <a href="#">Using Hold and Resume, page 19</a> .
	Remote-in-use	Another phone that shares your line has a connected call. See <a href="#">Using a Shared Line, page 31</a> , for details.
	Authenticated call	See <a href="#">Making and Receiving Secure Calls, page 34</a> .
	Encrypted call	See <a href="#">Making and Receiving Secure Calls, page 34</a> .
	Idle line (BLF)	See <a href="#">Using BLF to Determine a Line State, page 36</a> .
	Busy line (BLF)	See <a href="#">Using BLF to Determine a Line State, page 36</a> .

## Recognizing Recording Tones

If your system administrator has configured your phone to support recording tones (also called beep tones), then the parties on a call might hear a beep tone which indicates that the call may be recorded. Ask your system administrator for more information.

## Understanding Feature Availability

Depending on your phone system configuration, features included in this Phone Guide might not be available to you or might work differently on your phone. Contact your support desk or system administrator for information about feature operation or availability.

## Understanding SIP vs. SCCP

Your phone can be configured to work with one of two signaling protocols: SIP (Session Initiation Protocol) or SCCP (Skinny Call Control Protocol). Your system administrator determines this configuration.





Phone features can vary depending on the protocol. This Phone Guide indicates which features are protocol-specific. To learn which protocol your phone is using, you can ask your system administrator or you can choose  > **Model Information** > **Call Control Protocol** on your phone.

# Basic Call Handling



You can perform basic call-handling tasks using a range of features and services. Feature availability can vary; see your system administrator for more information.

## Placing a Call—Basic Options

Here are some easy ways to place a call on your Cisco Unified IP Phone.

If you want to...	Then...	For more information, see...
Place a call using the handset	Pick up the handset and enter a number.	<a href="#">An Overview of Your Phone, page 8</a>
Place a call using the speakerphone	Press  and enter a number.	<a href="#">Using a Handset, Headset, and Speakerphone, page 37</a>
Place a call using a headset	Press  and enter a number. Or if  is lit, press <b>New Call</b> and enter a number.	<a href="#">Using a Handset, Headset, and Speakerphone, page 37</a>
Redial a number	Press <b>Redial</b> to dial the last number, or press the <b>Navigation</b> button (with the phone idle) to see your Placed Calls.	<a href="#">Using Call Logs, page 41</a>
Place a call when another call is active (using the same line)	<ol style="list-style-type: none"><li>1. Press <b>Hold</b>.</li><li>2. Press <b>New Call</b>.</li><li>3. Enter a number.</li></ol>	<a href="#">Using Hold and Resume, page 19</a>
Dial from a call log	<ol style="list-style-type: none"><li>1. Choose  &gt; <b>Missed Calls</b>, <b>Received Calls</b>, or <b>Placed Calls</b>.</li><li>2. Select the listing or scroll to it and go off-hook.</li></ol>	<a href="#">Using Call Logs, page 41</a>



### Tips

- You can dial on-hook, without a dial tone (pre-dial). To pre-dial, enter a number, then go off-hook by lifting the handset or pressing **Dial**, , or .
- When you pre-dial, your phone tries to anticipate the number you are dialing by displaying matching numbers (if available) from your Placed Calls log. This is called Auto Dial. To call a number displayed with Auto Dial, press the number, or scroll to it and go off-hook.
- If you make a mistake while dialing, press << to erase digits.



## Placing a Call—Additional Options







You can place calls using special features and services that might be available on your phone. See your system administrator for more information about these additional options.

If you want to...	Then...	For more information, see...
Place a call while another call is active (using a different line)	<ol style="list-style-type: none"> <li>1. Press  for the new line. The first call is automatically placed on hold.</li> <li>2. Enter a number.</li> </ol>	<a href="#">Using Hold and Resume, page 19</a>
Speed dial a number	Do one of the following: <ul style="list-style-type: none"> <li>• Press  (a speed-dial button).</li> <li>• Use the Abbreviated Dial feature.</li> <li>• Use the Fast Dial feature.</li> </ul>	<a href="#">Speed Dialing, page 29</a>
Dial from a corporate directory on the phone	<ol style="list-style-type: none"> <li>1. Choose  &gt; <b>Corporate Directory</b> (exact name can vary).</li> <li>2. Enter a name and press <b>Search</b>.</li> <li>3. Highlight a listing and go off-hook.</li> </ol>	<a href="#">Using Call Logs, page 41</a>
Dial from a corporate directory on your personal computer using Cisco WebDialer	<ol style="list-style-type: none"> <li>1. Open a web browser and go to a WebDialer-enabled corporate directory.</li> <li>2. Click the number that you want to dial.</li> </ol>	<a href="#">Using Cisco WebDialer, page 57</a>
Use Cisco CallBack to receive notification when a busy or ringing extension is available	<ol style="list-style-type: none"> <li>1. Press <b>CallBack</b> while listening to the busy tone or ring sound.</li> <li>2. Hang up. Your phone alerts you when the line is free.</li> <li>3. Place the call again.</li> </ol>	Your system administrator
See if a line associated with a speed-dial, call record, or directory listing is busy before placing a call to that line	Look for Busy Lamp Field indicators.	<a href="#">Using BLF to Determine a Line State, page 36</a>
Make a priority (precedence) call (SCCP phones only)	Enter the MLPP access number, then enter the phone number.	<a href="#">Prioritizing Critical Calls, page 35</a>

<b>If you want to...</b>	<b>Then...</b>	<b>For more information, see...</b>
Dial from a Personal Address Book (PAB) entry	<ol style="list-style-type: none"> <li>1. Choose  &gt; <b>Personal Directory</b> to log in.</li> <li>2. Choose <b>Personal Address Book</b> and search for a listing.</li> </ol>	<a href="#">Using Personal Directory on Your Phone, page 45</a>
Place a call using a billing or tracking code (SCCP phones only)	<ol style="list-style-type: none"> <li>1. Dial a number.</li> <li>2. After the tone, enter a client matter code (CMC) or a forced authorization code (FAC).</li> </ol>	Your system administrator
Place a call using your Cisco Unified Extension Mobility profile	Log in to the Extension Mobility service on a phone.	<a href="#">Using Cisco Extension Mobility, page 36</a>

## Answering a Call



You can answer a call by lifting the handset, or you can use other options if they are available on your phone.

<b>If you want to...</b>	<b>Then...</b>	<b>For more information, see...</b>
Answer with a headset	Press  , if unlit. Or, if  is already lit, press <b>Answer</b> or  (flashing).	<a href="#">Using a Handset, Headset, and Speakerphone, page 37</a>
Answer with the speakerphone	Press  , <b>Answer</b> , or  (flashing).	<a href="#">Using a Handset, Headset, and Speakerphone, page 37</a>
Switch from a connected call to answer a new call	Press <b>Answer</b> , or if the call is ringing on a different line, press  (flashing).	<a href="#">Using Hold and Resume, page 19</a>
Answer using call waiting	Press <b>Answer</b> .	<a href="#">Using Hold and Resume, page 19</a>
Send a call to a voice messaging system	Press <b>iDivert</b> .	<a href="#">Sending a Call to a Voice Messaging System, page 22</a>
Auto-connect calls	Use <b>AutoAnswer</b> .	<a href="#">Using AutoAnswer, page 38</a>
Retrieve a parked call on another phone	Use <b>Call Park</b> .	<a href="#">Storing and Retrieving Parked Calls, page 33</a>

If you want to...	Then...	For more information, see...
Use your phone to answer a call ringing elsewhere	Use Call Pickup.	<a href="#">Picking Up a Redirected Call on Your Phone</a> , page 30
Answer a priority call (SCCP phones only)	Hang up the current call and press <b>Answer</b> .	<a href="#">Prioritizing Critical Calls</a> , page 35

## Ending a Call

To end a call, hang up. Here are some more details.

If you want to...	Then...
Hang up while using the handset	Return the handset to its cradle. Or press <b>EndCall</b> .
Hang up while using the headset	Press  . If you want to keep headset mode activate, press <b>EndCall</b> .
Hang up while using the speakerphone	Press  or <b>EndCall</b> .
Hang up one call but preserve another call on the same line	Press <b>EndCall</b> . If necessary, remove the call from hold first.

## Using Hold and Resume

You can hold and resume calls.



If you want to...	Then...
Put a call on hold	<ol style="list-style-type: none"> <li>1. Make sure the call you want to put on hold is highlighted.</li> <li>2. Press <b>Hold</b>.</li> </ol>
Remove a call from hold on the current line	<ol style="list-style-type: none"> <li>1. Make sure that the appropriate call is highlighted.</li> <li>2. Press <b>Resume</b>.</li> </ol>
Remove a call from hold on a different line	<p>Press  for the appropriate line.</p> <p>If a single call holding on this line, the call automatically resumes. If multiple calls are holding, scroll to the appropriate call and press <b>Resume</b>.</p>

### Tips

- Engaging the Hold feature typically generates music or a beeping tone.
- A held call is indicated by the call-on-hold icon: .



## Using Mute

With Mute enabled, you can hear other parties on a call but they cannot hear you. You can use Mute in conjunction with the handset, speakerphone, or a headset.

If you want to...	Then...
Toggle Mute on	Press  .
Toggle Mute off	Press  .

## Switching Between Multiple Calls

You can switch between multiple calls on one or more lines. If the call that you want to switch to is not automatically highlighted, use the Navigation button to scroll to it.

If you want to...	Then...
Switch between connected calls on one line	<ol style="list-style-type: none"><li>1. Make sure the call that you want to switch to is highlighted.</li><li>2. Press <b>Resume</b>.</li></ol> Any active call is placed on hold and the selected call is resumed.
Switch between connected calls on different lines	Press  for the line that you are switching to. If a single call is holding on the line, the call automatically resumes. If multiple calls are holding, highlight the appropriate call and press <b>Resume</b> .
Switch from a connected call to answer a ringing call	Press <b>Answer</b> , or if the call is ringing on a different line press  (flashing). Any active call is placed on hold and the selected call is resumed.





## Viewing Multiple Calls

Understanding how multiple calls are displayed on your phone can help you organize your call-handling efforts.

In standard viewing mode, your phone displays calls as follows for the highlighted line:

- Calls with the highest precedence and longest duration display at the top of the list.
- Calls of a similar type are grouped together. For example, calls that you have interacted with are grouped near the top, and calls on hold are grouped last.

You can use these additional methods to view multiple calls on multiple lines:

If you want to...	Then...
View calls on another line	<ol style="list-style-type: none"> <li>1. Press .</li> <li>2. Immediately press the line button .</li> </ol>
Switch to call overview mode	<p>Press  for the highlighted line.</p> <p>The phone switches to call overview mode, displaying one call per line. The displayed call is either the active call or the held call with the longest duration.</p> <p>To return to standard viewing mode, press , then immediately press the line button.</p>

## Transferring Calls

Transfer redirects a connected call. The *target* is the number to which you want to transfer the call.

If you want to...	Then...
Transfer a call without talking to the transfer recipient	<ol style="list-style-type: none"> <li>1. From an active call, press <b>Transfer</b>.</li> <li>2. Enter the target number.</li> <li>3. Press <b>Transfer</b> again to complete the transfer or <b>EndCall</b> to cancel.</li> </ol> <p><b>Note</b> If your phone supports on-hook transfer, you can alternately complete the transfer by hanging up.</p>
Talk to the transfer recipient before transferring a call (consult transfer)	<ol style="list-style-type: none"> <li>1. From an active call, press <b>Transfer</b>.</li> <li>2. Enter the target number.</li> <li>3. Wait for the transfer recipient to answer.</li> <li>4. Press <b>Transfer</b> again to complete the transfer or <b>EndCall</b> to cancel.</li> </ol> <p><b>Note</b> If your phone supports on-hook transfer, you can alternately complete the transfer by hanging up.</p>

If you want to...	Then...
Transfer two current calls to each other (direct transfer) without staying on the line (SCCP phones only)	<ol style="list-style-type: none"> <li>1. Scroll to highlight any call on the line.</li> <li>2. Press <b>Select</b>.</li> <li>3. Repeat this process for the second call.</li> <li>4. With one of the selected calls highlighted, press <b>DirTrfr</b>. (To display <b>DirTrfr</b>, you might need to press <b>more</b>.)</li> </ol> <p>The two calls connect to each other and drop you from the call.</p> <p><b>Note</b> If you want to stay on the line with the callers, use <b>Join</b> instead.</p>
Redirect a call to a voice messaging system	Press <b>iDivert</b> . For more information, see <a href="#">Sending a Call to a Voice Messaging System, page 22</a> .

### Tips

- If on-hook transfer is enabled on your phone, you can either hang up to complete the call, or press **Transfer** and then hang up.
- If on-hook transfer is *not* enabled on your phone, hanging up without pressing **Transfer** again places the call on hold.
- You cannot use **Transfer** to redirect a call on hold. Press **Resume** to remove the call from hold before transferring it.

## Sending a Call to a Voice Messaging System

You can use **iDivert** to send an active, ringing, or on-hold call to your voice messaging system. Depending on the type of call and your phone configuration, you can also use **iDivert** to send the call to another party's voice messaging system.

- If the call was originally sent to someone else's phone, **iDivert** allows you to redirect the call either to your own voice messaging system or to the original called party's voice messaging system. Your system administrator must make this option available to you.
- If the call was sent to you directly (not transferred or forwarded to you), or if your phone does not support the option described above, using **iDivert** redirects the call to your voice messaging system.

If you want to...	Then...
Send an active, ringing, or on-hold call to a voice messaging system	Press <b>iDivert</b> . One of two things occurs: <ul style="list-style-type: none"> <li>• The call is transferred to your voice messaging system.</li> <li>• Your phone screen displays a menu that allows you to choose between your voice messaging system or the voice messaging system of the original called party. Choose an option to redirect the call.</li> </ul>

### Tip

If your phone displays a menu that disappears before you make your selection, you can press **iDivert** again to re-display the menu. You can also ask your system administrator to configure a longer timeout value.

## Forwarding All Calls to Another Number

You can use Call Forward All to redirect incoming calls from your phone to another number.

If you want to...	Then...
Set up call forwarding on your primary line	Press <b>CFwdALL</b> and enter a target phone number.
Cancel call forwarding on your primary line	Press <b>CFwdALL</b> .
Verify that call forwarding is enabled on your primary line	Look for: <ul style="list-style-type: none"> <li>• The call forward icon above the primary phone number: .</li> <li>• The call forwarding target number in the status line.</li> </ul>
Set up or cancel call forwarding remotely, or for a non-primary line	<ol style="list-style-type: none"> <li>1. Log in to your User Options web pages. (See <a href="#">Accessing Your User Options Web Pages, page 49.</a>)</li> <li>2. Access your call forwarding settings (See <a href="#">Controlling Line Settings on the Web, page 55.</a>)</li> </ol> <p><b>Note</b> When call forwarding is enabled for any line other than the primary line, your phone does not provide you with any confirmation that calls are being forwarded. Instead, you must confirm your settings in the User Options web pages.</p>



## Tips

- Enter the call forward target number exactly as you would dial it from your phone. For example, enter an access code or the area code, if necessary.
- You can forward your calls to a traditional analog phone or to another IP phone, although your system administrator might restrict the call forwarding feature to numbers within your company.
- Call forwarding is phone line specific. If a call reaches you on a line where call forwarding is not enabled, the call will ring as usual.
- Your system administrator can enable a call forward override feature that allows the person receiving your forwarded calls to reach you. With override enabled, a call placed from the target phone to your phone is not forwarded, but rings through.
- Your system administrator can change call forwarding conditions for your phone lines.

## Using Do Not Disturb

(SIP phones only.)

You can use the Do Not Disturb (DND) feature to block incoming calls on your phone with a busy tone.

If you want to...	Then...
Turn on DND	<ol style="list-style-type: none"><li>1. Press  &gt; Device Configuration &gt; Call Preferences &gt; Do Not Disturb.</li><li>2. Select Yes, and then press Save.</li></ol> <p>“Do Not Disturb” displays on the status line, and a DND softkey is added.</p>
Turn off DND	<p>Press the DND softkey or:</p> <ol style="list-style-type: none"><li>1. Press  &gt; Device Configuration &gt; Call Preferences &gt; Do Not Disturb.</li><li>2. Select No, and then press Save.</li></ol>

## Tips

- When DND is turned on:
  - The DND blocking feature applies to all the lines on your phone.
  - Received calls are not logged to the Missed Calls directory on your phone.
- When DND and Call Forward All are both enabled on your phone, Call Forward All takes precedence on incoming calls. That is, calls will be forwarded and the caller will not hear a busy tone.
- If DND is not enabled on your phone, see your system administrator.



# Making Conference Calls

Your Cisco Unified IP Phone allows you to combine three or more separate calls into one conversation, creating a conference call.

## Understanding Types of Conference Calls

There are two types of conference calls: Standard (ad hoc) and Meet-Me.

### Standard Conference Calls

You can create a standard conference in different ways, depending on your needs and the softkeys available on your phone:

- **Confrn**—Use this softkey to establish a standard conference by calling each participant. Standard conference calling is a default feature available on most phones.
- **Join**—Use this softkey to establish a standard conference by joining several calls already on one line. (SCCP phones only)
- **cBarge**—Use this softkey to add yourself to an existing call on a shared line and to turn the call into a standard conference call. This feature is available only on phones that use shared lines.

See [Starting and Joining a Standard Conference, page 26](#), for additional instructions.

### Meet-Me Conference Calls

You can create a Meet-Me conference by calling the Meet-Me phone number at a specified time.

See [Starting or Joining a Meet-Me Conference Call, page 28](#), for additional instructions.

## Starting and Joining a Standard Conference

A standard (ad hoc) conference allows at least three people to participate in a single call.

If you want to...	Then...
<ul style="list-style-type: none"> <li>• Create a conference by calling participants</li> <li>• Add new participants to an existing conference</li> </ul>	<ol style="list-style-type: none"> <li>1. From a connected call, press <b>Confren</b>. (You may need to press the <b>more</b> softkey to see <b>Confren</b>.)</li> <li>2. Enter the participant's phone number.</li> <li>3. Wait for the call to connect.</li> <li>4. Press <b>Confren</b> again to add the participant to your call.</li> <li>5. Repeat to add additional participants.</li> </ol>
<p>Create a conference by joining two or more existing calls (SCCP phones only)</p>	<ol style="list-style-type: none"> <li>1. Make sure that you have two or more calls on a single line.</li> <li>2. Highlight a call that you want to add to the conference.</li> <li>3. Press <b>Select</b>. The selected call displays this icon .</li> <li>4. Repeat this process for each call that you want to add.</li> <li>5. From one of the selected calls, press <b>Join</b>. (You may need to press the <b>more</b> softkey to see <b>Join</b>.)</li> </ol> <p><b>Note</b> The active call is automatically selected.</p>
<p>Participate in a conference</p>	<p>Answer the phone when it rings.</p>
<p>Create a conference by barging a call on a shared line</p>	<p>Highlight a call on a shared line and press <b>cBarge</b>. (You may need to press the <b>more</b> softkey to display <b>cBarge</b>.)</p> <p>See <a href="#">Using a Shared Line, page 31</a>.</p>
<p>View a list of conference participants</p>	<ol style="list-style-type: none"> <li>1. Highlight an active conference.</li> <li>2. Press <b>ConfList</b>.</li> </ol> <p>Participants are listed in the order in which they join the conference with the most recent additions at the top.</p>
<p>Get an updated list of participants</p>	<p>While viewing the conference list, press <b>Update</b>.</p>
<p>See who started the conference</p>	<p>While viewing the conference list, locate the person listed at the bottom of the list with an asterisk (*) next to the name.</p>
<p>Drop the last party added to the conference</p>	<p>Press <b>RmLstC</b>.</p> <p>You can remove participants only if you initiated the conference call.</p>

If you want to...	Then...
Remove any conference participant	<ol style="list-style-type: none"> <li>1. Highlight the participant's name.</li> <li>2. Press <b>Remove</b>.</li> </ol> <p style="margin-left: 40px;">You can remove participants only if you initiated the conference.</p>
End your participation in a conference	Hang up or press <b>EndCall</b> .

### Tips

- Calls must be on the same line before you can add them to a conference. If calls are on different lines, transfer them to a single line before using **Confrn** or **Join**. (**Join** is on SCCP phones only.)
- Depending on how your phone is configured, if you leave a conference after creating it, the conference might end. To avoid this, transfer the conference before hanging up.

## Starting or Joining a Meet-Me Conference Call

Meet-Me conferencing allows you to start or join a conference by calling the conference number.

If you want to...	Then...
Start a Meet-Me conference	<ol style="list-style-type: none"><li>1. Obtain a Meet-Me phone number from your system administrator.</li><li>2. Distribute the number to participants.</li><li>3. When you are ready to start the meeting, go off-hook to invoke a dial tone, then press <b>MeetMe</b>.</li><li>4. Dial the Meet-Me conference number. Participants can now join the conference by dialing in.</li></ol> <p><b>Note</b> Participants hear a busy tone if they call the conference before the initiator has joined. In this case, participants must call back.</p>
Join a Meet-Me conference	<p>Dial the Meet-Me conference number (provided by the conference initiator).</p> <p><b>Note</b> Participants hear a busy tone if they call the conference before the initiator has joined. In this case, try your call again.</p>
End a Meet-Me conference	<p>All participants must hang up.</p> <p>The conference does not automatically end when the conference initiator disconnects.</p>

# Advanced Call Handling

Advanced call-handling tasks involve special features that your system administrator might configure for your phone depending on your call-handling needs and work environment.

## Speed Dialing

Speed dialing allows you to enter an index number, press a button, or select a phone screen item to place a call. Depending on configuration, your phone can support several speed-dial features:

- Speed-dial buttons
- Abbreviated Dialing
- Fast Dials



### Note

- To set up speed-dial buttons and Abbreviated Dial, you must access your User Options web pages. See [Accessing Your User Options Web Pages, page 49](#).
- To set up Fast Dials, you must access the Personal Directory feature. See [Using Personal Directory on Your Phone, page 45](#).
- Alternately, your system administrator can configure speed-dial features for you.

If you want to...	Then...
Use speed-dial buttons	<ol style="list-style-type: none"> <li>1. Set up speed-dial buttons. See <a href="#">Setting Up Speed Dials on the Web, page 52</a>.</li> <li>2. To place a call, press  (a speed-dial button).</li> </ol> <p><b>Note</b> If your phone supports the Busy Lamp Field (BLF) speed-dial feature, you can see if the speed-dial number is busy before dialing. See <a href="#">Using BLF to Determine a Line State, page 36</a>.</p>
Use Abbreviated Dial	<ol style="list-style-type: none"> <li>1. Set up Abbreviated Dialing codes. See <a href="#">Setting Up Speed Dials on the Web, page 52</a>.</li> <li>2. To place a call, enter the Abbreviated Dialing code and press <b>AbbrDial</b>.</li> </ol>
Use Fast Dial	<ol style="list-style-type: none"> <li>1. Create a Personal Address Book entry and assign a Fast Dials code. See <a href="#">Using Personal Directory on the Web, page 50</a>.</li> <li>2. To place a call, access the Fast Dial service on your phone. See <a href="#">Using Personal Directory on Your Phone, page 45</a>.</li> </ol>

# Picking Up a Redirected Call on Your Phone

Call PickUp allows you to answer a call that is ringing on a coworker's phone by redirecting the call to your phone. You might use Call PickUp if you share call-handling with coworkers.

If you want to...	Then...
Answer a call that is ringing on another extension within your call pickup group	<ol style="list-style-type: none"><li>1. Do one of the following:<ul style="list-style-type: none"><li>• If the <b>PickUp</b> softkey is available, press it.</li><li>• If the <b>PickUp</b> softkey is not available, go off-hook to display it, then press <b>PickUp</b>.</li></ul>If your phone supports auto-pickup, you are now connected to the call.</li><li>2. If the call rings, press <b>Answer</b> to connect to the call.</li></ol>
Answer a call that is ringing on another extension outside of your group	<ol style="list-style-type: none"><li>1. Do one of the following:<ul style="list-style-type: none"><li>• If the <b>GPickUp</b> softkey is available, press it.</li><li>• If the <b>GPickUp</b> softkey is not available, go off-hook to display it, then press <b>GPickUp</b>.</li></ul></li><li>2. Enter the group pickup code. If your phone supports auto-pickup, you are now connected to the call.</li><li>3. If the call rings, press <b>Answer</b> to connect to the call.</li></ol>
Answer a call that is ringing on another extension in your group or in an associated group	<ol style="list-style-type: none"><li>1. Do one of the following:<ul style="list-style-type: none"><li>• If the <b>OPickUp</b> softkey is available, press it.</li><li>• If the <b>OPickUp</b> softkey is not available, go off-hook to display it, then press <b>OPickUp</b>.</li></ul>If your phone supports auto-pickup, you are now connected to the call.</li><li>2. If the call rings, press <b>Answer</b> to connect to the call.</li></ol>

## Tips

- Pressing **PickUp** and **GPickUp** connects you to the call that has been ringing for the longest time.
- Pressing **OPickUp** connects you to the call in the pickup group with the highest priority.
- If you have multiple lines and want to pick up the call on a non-primary line, first press  for the desired line, then press a Call PickUp softkey.

## Using a Shared Line

Your system administrator might ask you to use a shared line if you:

- Have multiple phones and want one phone number
- Share call-handling tasks with coworkers
- Handle calls on behalf of a manager

## Understanding Shared Lines

### Remote-in-Use Icon

The Remote-in-Use icon  appears when another phone that shares your line has a connected call. You can place and receive calls as usual on the shared line, even when the Remote-in-Use icon appears.

### Sharing Call Information and Barging

Phones that share a line each display information about calls that are placed and received on the shared line. This information might include caller ID and call duration. (See the [Privacy](#) section for exceptions.)

When call information is visible in this way, you and coworkers who share a line can add yourselves to calls using either **Barge** or **cBarge**. See [Adding Yourself to a Shared-Line Call](#), page 32.

### Privacy

If you do not want coworkers who share your line to see information about your calls, enable the Privacy feature. Doing so also prevents coworkers from barging your calls. See [Preventing Others from Viewing or Barging a Shared-Line Call](#), page 33.



---



**Note**

The maximum number of calls that a shared line supports can vary by phone.

---

## Adding Yourself to a Shared-Line Call

Depending on how your phone is configured, you can add yourself to a call on a shared line using either **Barge** or **cBarge**.

If you want to...	Then...
See if the shared line is in use	Look for the remote-in-use icon  next to a red line button  .
View details about current calls on the shared line	Press the red line button  for the remote-in-use line. All non-private calls appear in the call activity area of the phone screen.
Add yourself to a call on a shared line using the <b>Barge</b> softkey	<ol style="list-style-type: none"><li data-bbox="373 513 763 545">1. Highlight a remote-in-use call.</li><li data-bbox="373 553 1219 626">2. Press <b>Barge</b>. (You may need to press the <b>more</b> softkey to display <b>Barge</b>.) Other parties hear a beep tone announcing your presence.</li></ol>
Add yourself to a call on a shared line using the <b>cBarge</b> softkey	<ol style="list-style-type: none"><li data-bbox="373 634 763 667">1. Highlight a remote-in-use call.</li><li data-bbox="373 675 1219 732">2. Press <b>cBarge</b>. (You may need to press the <b>more</b> softkey to display <b>cBarge</b>.) Other parties hear a tone and brief audio interruption, and call information changes on the phone screen.</li></ol>
Add new conference participants to a call that you have barged	Barge the call using <b>cBarge</b> , if available. Unlike <b>Barge</b> , <b>cBarge</b> converts the call into a standard (ad hoc) conference call, allowing you to add new conference participants. See the <a href="#">“Making Conference Calls” section on page 25</a> .
Leave a barged call	Hang up. If you hang up after using <b>Barge</b> , the remaining parties hear a disconnect tone and the original call continues. If you hang up after using <b>cBarge</b> , the call remains a conference call (provided at least three participants remain on the line).







### Tips

- If a phone that is using the shared line has Privacy enabled, call information and barge softkeys will not appear on the other phones that share the line.
- You will be disconnected from a call that you have joined using **Barge** if the call is put on hold, transferred, or turned into a conference call.



## Preventing Others from Viewing or Barging a Shared-Line Call

If you share a phone line, you can use the Privacy feature to prevent others who share the line from viewing or barging (adding themselves to) your calls.

If you want to...	Then...
Prevent others from viewing or barging calls on a shared line	<ol style="list-style-type: none"> <li>1. Press <b>Private</b> .</li> <li>2. To verify that Privacy is on, look for the Privacy-enabled icon  next to an amber line button .</li> </ol>
Allow others to view or barge calls on a shared line	<ol style="list-style-type: none"> <li>1. Press <b>Private</b> .</li> <li>2. To verify that Privacy is off, look for the Privacy-disabled icon  next to an unlit line button .</li> </ol>

### Tips

- If the phone that shares your line has Privacy enabled, you can make and receive calls using the shared line as usual.
- The Privacy feature applies to all shared lines on your phone. Consequently, if you have multiple shared lines and Privacy is enabled, coworkers will not be able to view or barge calls on any of your shared lines.

## Storing and Retrieving Parked Calls

You can park a call when you want to store the call so that you or someone else can retrieve it from another phone in the Cisco Unified CallManager system (for example, a phone at a coworker's desk or in a conference room).

If you want to...	Then...
Store an active call using Call Park	<ol style="list-style-type: none"> <li>1. During a call, press <b>Park</b>. (You may need to press the <b>more</b> softkey to see <b>Park</b>.)</li> <li>2. Note the call park number displayed on your phone screen.</li> <li>3. Hang up.</li> </ol>
Retrieve a parked call	Enter the call park number from any Cisco Unified IP Phone in your network to connect to the call.



### Note



You have a limited amount of time to retrieve a parked call before it reverts to ringing at the original number. See your system administrator for details.

## Making and Receiving Secure Calls

Depending on how your system administrator has configured your phone system, your phone might support making and receiving secure calls.

Your phone is capable of supporting these types of calls:

- *Authenticated* call—The identities of all phones participating in the call have been verified.
- *Encrypted* call—The phone is receiving and transmitting encrypted audio (your conversation) within the Cisco IP network. Encrypted calls are also authenticated.
- *Non-secure* call—At least one of the participating phones or the connection does not support these security features, or the phones cannot be verified.

If you want to...	Then...
Check the security level of a call	Look for a security icon in the top right corner of the call activity area, next to the call duration timer:  Authenticated call  Encrypted call Neither security icon appears if the call is non-secure.
Determine if secure calls can be made in your company	Contact your system administrator.



**Note** There are interactions, restrictions, and limitations that affect how security features work on your phone. For more information, ask your system administrator.

## Tracing Suspicious Calls

(SCCP phones only.)

If you are receiving suspicious or malicious calls, your system administrator can add the Malicious Call Identification (MCID) feature to your phone. This feature enables you to identify an active call as suspicious, which initiates a series of automated tracking and notification messages.

If you want to...	Then...
Notify your system administrator about a suspicious or harassing call	Press <b>MCID</b> . Your phone plays a tone and displays the message, “MCID successful”.





## Prioritizing Critical Calls

(SCCP phones only.)

In some specialized environments, such as military or government offices, you might need to make and receive urgent or critical calls. If you have the need for this specialized call handling, your system administrator can add Multilevel Precedence and Preemption (MLPP) to your phone.

Keep these terms in mind:

- *Precedence* indicates the priority associated with a call.
- *Preemption* is the process of ending an existing, lower priority call while accepting a higher priority call that is sent to your phone.



If you...	Then...
Want to choose a priority (precedence) level for an outgoing call	Contact your system administrator for a list of corresponding precedence numbers for calls.
Want to make a priority (precedence) call	Enter the MLPP access number (provided by your system administrator) followed by the phone number.
Hear a special ring (faster than usual) or special call waiting tone	You are receiving a priority (precedence) call. An MLPP icon on your phone screen indicates the priority level of the call.
Want to view priority level of a call	<p>Look for an MLPP icon on your phone screen:</p> <ul style="list-style-type: none"> <li> Priority call</li> <li> Medium priority (immediate) call</li> <li> High priority (flash) call</li> <li> Highest priority (flash override) or Executive Override call</li> </ul> <p>Higher priority calls are displayed at the top of your call list. If you do not see an MLPP icon, the priority level of the call is normal (routine).</p>
Want to accept a higher-priority call	Answer the call as usual. If necessary, end an active call first.
Hear a continuous tone interrupting your call	You or the other party are receiving a call that must preempt the current call. Hang up immediately to allow the higher priority call to ring through.

### Tips

- When you make or receive an MLPP-enabled call, you will hear special ring tones and call waiting tones that differ from the standard tones.
- If you enter an invalid MLPP access number, a verbal announcement will alert you of the error.

# Using Cisco Extension Mobility

Cisco Extension Mobility (EM) allows you to temporarily configure a Cisco Unified IP Phone as your own. Once you log in to EM, the phone adopts your user profile, including your phone lines, features, established services, and web-based settings. Your system administrator must configure EM for you.









If you want to...	Then...
Log in to EM	<ol style="list-style-type: none"><li>1. Choose  &gt; EM Service (name can vary).</li><li>2. Enter your user ID and PIN (provided by your system administrator).</li><li>3. If prompted, select a device profile.</li></ol>
Log out of EM	<ol style="list-style-type: none"><li>1. Choose  &gt; EM Service (name can vary).</li><li>2. When prompted to log out, press Yes.</li></ol>

## Tips

- EM automatically logs you out after a certain amount of time. This time limit is established by your system administrator.
- Changes that you make to your EM profile (from the User Options web pages) take effect the next time that you log in to EM on a phone.
- Settings that are controlled on the phone only are not maintained in your EM profile.









# Using BLF to Determine a Line State

Depending on configuration, you can use the Busy Lamp Field (BLF) to determine the state of another phone line that is associated with a speed-dial button, call log, or directory listing on your phone. You can place a call to this line, regardless of the BLF status. This feature does not prevent dialing.

If you want to...	Then...
See the state of a speed-dial line	Look for one of these indicators next to the line number:  +  Line is in-use.  +  Line is idle.  BLF indicator unavailable for this line.
See the state of a line listed in a call log or directory	Look for one of these indicators next to the line number:  Line is in-use.  Line is idle.  BLF indicator unavailable for this line.

# Using a Handset, Headset, and Speakerphone

You can use your phone with a handset, headset, or speakerphone.



If you want to...	Then...
Use the handset	Lift it to go off-hook; replace it to go on-hook.
Use a headset	<p>Press  to toggle headset mode on and off. You can use a headset in conjunction with all of the controls on your phone, including  and .</p> <p>If you use AutoAnswer, see <a href="#">Using AutoAnswer, page 38</a>.</p> <p>If you use a headset that supports wideband, you might experience improved audio sensitivity if you enable the wideband setting on your phone (this setting is disabled by default). To access the setting, choose  &gt; <b>User Preferences &gt; Audio Preferences &gt; Wideband Headset.</b></p> <p>Check with your system administrator to be sure your phone system is configured to use wideband. If the system is not configured for wideband, you may not detect any additional audio sensitivity even when using a wideband headset. To learn more about your headset, refer to the headset documentation or ask your system administrator for assistance.</p>
Use the speakerphone	<p>Press  to toggle speakerphone mode on or off.</p> <p>Many of the actions you can take to dial a number or answer a call will automatically trigger speakerphone mode, assuming that the handset is in its cradle and  is not lit.</p>
Switch to the headset or speakerphone (from the handset) during a call	Press  or  , then hang up the handset.
Switch to the handset (from the speakerphone or headset) during a call	Lift the handset (without pushing any buttons).
Adjust the volume level for a call	<p>Press  during a call or after invoking a dial tone.</p> <p>This action adjusts the volume for the handset, speakerphone, or headset, depending on which device is in use.</p> <p>Press <b>Save</b> to preserve the volume level for future calls.</p>

## Obtaining a Headset

Your phone supports four- or six-wire headset jacks. For information about purchasing headsets, see [Headset Information, page 7](#).

## Using AutoAnswer

When AutoAnswer is enabled, your phone answers incoming calls automatically after a few rings. Your system administrator configures AutoAnswer to use either the speakerphone or a headset. You might use AutoAnswer if you receive a high volume of incoming calls.

If you...	Then...
Use AutoAnswer with a headset	Keep headset mode active (in other words, keep  illuminated) even when you are not on a call.  To keep headset mode active, do one of the following: <ul style="list-style-type: none"><li>• Press <b>EndCall</b> to hang up.</li><li>• Press <b>New Call</b> or <b>Dial</b> to place new calls.</li></ul> If your phone is set up to use AutoAnswer in headset mode, calls will be answered automatically only if  is illuminated. Otherwise, calls ring normally and you must manually answer them.
Use AutoAnswer with the speakerphone	Keep the handset in the cradle and headset mode inactive (  unlit). Otherwise, calls ring normally and you must manually answer them.

# Using Phone Settings

You can customize your Cisco Unified IP Phone by adjusting the ring tone, background image, and other settings.



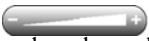

## Customizing Rings and Message Indicators

You can customize how your phone indicates an incoming call and a new voice mail message. You can also adjust the ringer volume for your phone.

If you want to...	Then...
Change the ring tone per line	<ol style="list-style-type: none"> <li>1. Choose  &gt; User Preferences &gt; Rings.</li> <li>2. Choose a phone line or the default ring setting.</li> <li>3. Choose a ring tone to play a sample of it.</li> <li>4. Press Select and Save to set the ring tone, or press Cancel.</li> </ol>
Change the ring pattern per line (flash-only, ring once, beep-only, etc.)	<ol style="list-style-type: none"> <li>1. Log in to your User Options web pages. (See <a href="#">Accessing Your User Options Web Pages, page 49.</a>)</li> <li>2. Access your call ring pattern settings. (See <a href="#">Controlling Line Settings on the Web, page 55.</a>)</li> </ol> <p><b>Note</b> Before you can access this setting, your system administrator might need to enable it for you.</p>
Adjust the volume level for the phone ringer	Press  while the handset is in the cradle and the headset and speakerphone buttons are off. The new ringer volume is saved automatically.
Change the way that the voice message light on your handset works	<ol style="list-style-type: none"> <li>1. Log in to your User Options web pages. (See <a href="#">Accessing Your User Options Web Pages, page 49.</a>)</li> <li>2. Access your message indicator settings. (See <a href="#">Controlling Line Settings on the Web, page 55.</a>)</li> </ol> <p><b>Note</b> Typically, the default system policy is to indicate a new voice message by displaying a steady light on the handset light strip.</p>

# Customizing the Phone Screen

You can adjust the characteristics of your phone screen.

If you want to...	Then...
Change the phone screen contrast	<ol style="list-style-type: none"> <li>1. Choose  &gt; <b>User Preferences &gt; Contrast.</b></li> <li>2. To make adjustments, press <b>Up</b>, <b>Down</b> or .</li> <li>3. Press <b>Save</b>, or press <b>Cancel</b>.</li> </ol> <p><b>Note</b> If you accidentally save a very light or very dark contrast and cannot see the phone screen display:</p> <p>Press  and then press <b>1, 3</b> on the keypad.</p> <p>Next, press  to change the contrast until you can see the phone screen display, and then press <b>Save</b>.</p>
Change the background image	<ol style="list-style-type: none"> <li>1. Choose  &gt; <b>User Preferences &gt; Background Images.</b></li> <li>2. Scroll through available images and press <b>Select</b> to choose an image.</li> <li>3. Press <b>Preview</b> to see a larger view of the background image.</li> <li>4. Press <b>Exit</b> to return to the selection menu.</li> <li>5. Press <b>Save</b> to accept the image or press <b>Cancel</b>.</li> </ol> <p><b>Note</b> If you do not see a selection of images, then this option has not been enabled on your system.</p>
Change the language on your screen	<ol style="list-style-type: none"> <li>1. Log in to your User Options web pages. (See <a href="#">Accessing Your User Options Web Pages, page 49.</a>)</li> <li>2. Access your user settings. (See <a href="#">Controlling User Settings on the Web, page 54.</a>)</li> </ol>
Change the line text label	<ol style="list-style-type: none"> <li>1. Log in to your User Options web pages. (See <a href="#">Accessing Your User Options Web Pages, page 49.</a>)</li> <li>2. Access your line label settings. (See <a href="#">Controlling Line Settings on the Web, page 55.</a>)</li> </ol>











# Using Call Logs and Directories

This section describes how you can use call logs and directories. To access both features, use the Directories button .

## Using Call Logs

Your phone maintains call logs. Call logs contain records of your missed, placed, and received calls.

If you want to...	Then...
View your call logs	Choose  > <b>Missed Calls, Placed Calls, or Received Calls</b> . Each stores up to 100 records.
Display details for a single call record	<ol style="list-style-type: none"> <li>1. Choose  &gt; <b>Missed Calls, Placed Calls, or Received Calls</b>.</li> <li>2. Highlight a call record.</li> <li>3. Press <b>Details</b>. Doing so displays information such as called number, calling number, time of day, and call duration (for placed and received calls only).</li> </ol>
Erase all call records in all logs	Press  , then press <b>Clear</b> .
Erase all call records in a single log	<ol style="list-style-type: none"> <li>1. Choose  &gt; <b>Missed Calls, Placed Calls, or Received Calls</b>.</li> <li>2. Highlight a call record.</li> <li>3. Press <b>Clear</b>. (You may need to press the <b>more</b> softkey to display <b>Clear</b>.)</li> </ol>
Erase a single call record	<ol style="list-style-type: none"> <li>1. Choose  &gt; <b>Missed Calls, Placed Calls, or Received Calls</b>.</li> <li>2. Highlight a call record.</li> <li>3. Press <b>Delete</b>.</li> </ol>
Dial from a call log (while not on another call)	<ol style="list-style-type: none"> <li>1. Choose  &gt; <b>Missed Calls, Placed Calls, or Received Calls</b>.</li> <li>2. Highlight a call record.</li> <li>3. If you need to edit the displayed number, press <b>EditDial</b> followed by &lt;&lt; or &gt;&gt;. To delete the number, press <b>EditDial</b> followed by <b>Delete</b>. (You may need to press the <b>more</b> softkey to display <b>Delete</b>.)</li> <li>4. Go off-hook to place the call.</li> </ol>

If you want to...	Then...
Dial from a call log (while connected to another call)	<ol style="list-style-type: none"> <li>1. Choose  &gt; <b>Missed Calls, Placed Calls, or Received Calls.</b></li> <li>2. Highlight a call record.</li> <li>3. If you need to edit the displayed number, press <b>EditDial</b> followed by &lt;&lt; or &gt;&gt;. To delete the number, press <b>EditDial</b> followed by <b>Delete</b>. (You may need to press the <b>more</b> softkey to display <b>Delete</b>.)</li> <li>4. Press <b>Dial</b>.</li> <li>5. Choose a menu item to handle the original call: <ul style="list-style-type: none"> <li>• <b>Hold</b>—Puts the first call on hold and dials the second.</li> <li>• <b>Transfer</b>—Transfers the first party to the second and drops you from the call. (Press <b>Transfer</b> again after dialing to complete the action.)</li> <li>• <b>Conference</b>—Creates a conference call with all parties, including you. (Press <b>Confrn</b> again after dialing to complete the action.)</li> <li>• <b>EndCall</b>—Disconnects the first call and dials the second.</li> </ul> </li> </ol>
See if the line in the call log is busy before placing a call to that line (SCCP phones only)	Look for Busy Lamp Field indicators. See <a href="#">Using BLF to Determine a Line State, page 36</a> .
Place a call from a URL entry in a call log (SIP phones only)	<ol style="list-style-type: none"> <li>1. Choose  &gt; <b>Missed Calls, Placed Calls, or Received Calls.</b></li> <li>2. Highlight the URL entry that you want to dial.</li> <li>3. If you need to edit the entry, press <b>EditDial</b>.</li> <li>4. The  icon appears to indicate that you can begin editing characters in the URL entry.</li> <li>5. Press <b>Dial</b>.</li> </ol>

**Tip**

(SCCP phones only)

To view the complete call record of a multiparty call (for example, of call that has been forwarded or transferred to you), highlight the call record and press **Details**. The Details record shows two entries for each missed or received multiparty call. The entries are listed in reverse chronological order:

- The first logged entry is the name/number of the last completed call of a multiparty call received on your phone.
- The second logged entry is the name/number of the first completed call of a multiparty call received on your phone.



## Directory Dialing

Depending on configuration, your phone can provide corporate and personal directory features:

- Corporate Directory—Corporate contacts that you can access on your phone. Corporate Directory is set up and maintained by your system administrator.
- Personal Directory—If available, personal contacts and associated speed-dial codes that you can configure and access from your phone and User Options web pages. Personal Directory is comprised of Personal Address Book (PAB) and Fast Dials:
  - PAB is a directory of your personal contacts.
  - Fast Dials allows you to assign codes to PAB entries for quick dialing.

## Using Corporate Directory on Your Phone

You can use a corporate directory to place calls to coworkers.

If you want to...	Then...
Dial from a corporate directory (while not on another call)	<ol style="list-style-type: none"><li>1. Choose  &gt; <b>Corporate Directory</b> (exact name can vary).</li><li>2. Use your keypad to enter a full or partial name and press <b>Search</b>.</li><li>3. To dial, select the listing, or scroll to the listing and go off-hook.</li></ol>
Dial from a corporate directory (while on another call)	<ol style="list-style-type: none"><li>1. Choose  &gt; <b>Corporate Directory</b> (exact name can vary).</li><li>2. Use your keypad to enter a full or partial name and press <b>Search</b>.</li><li>3. Scroll to a listing and press <b>Dial</b>.</li><li>4. Choose a menu item to handle the original call:<ul style="list-style-type: none"><li>• <b>Hold</b>—Puts the first call on hold and dials the second.</li><li>• <b>Transfer</b>—Transfers the first party to the second and drops you from the call. (Press <b>Transfer</b> again after dialing to complete the action.)</li><li>• <b>Conference</b>—Creates a conference call with all parties, including you. (Press <b>Confrn</b> again after dialing to complete the action.)</li><li>• <b>EndCall</b>—Disconnects the first call and dials the second.</li></ul></li></ol>
See if the phone line in the directory is busy	Look for Busy Lamp Field (BLF) indicators. See <a href="#">Using BLF to Determine a Line State, page 36</a> .



### Tip

Use the numbers on your keypad to enter characters on your phone screen. Use the Navigation button on your phone to move between input fields.

## Using Personal Directory on Your Phone

The Personal Directory feature set contains your Personal Address Book (PAB) and Fast Dials. This section describes how to set up and use Personal Directory on your phone. Alternately, see [Using Personal Directory on the Web, page 50](#).

If you want to...	Then...
Access Personal Directory (for PAB and Fast Dial codes)	<ol style="list-style-type: none"> <li>1. Choose  &gt; <b>Personal Directory</b> (exact name can vary).</li> <li>2. Enter your Cisco Unified CallManager user ID and PIN, then press <b>Submit</b>.</li> </ol>
Search for a PAB entry	<ol style="list-style-type: none"> <li>1. Access Personal Directory, then choose <b>Personal Address Book</b>.</li> <li>2. Enter search criteria and press <b>Submit</b>.</li> <li>3. You can choose <b>Previous</b> or <b>Next</b> to move through listings.</li> <li>4. Highlight the PAB listing that you want and press <b>Select</b>.</li> </ol>
Dial from a PAB entry	<ol style="list-style-type: none"> <li>1. Search for a listing.</li> <li>2. Highlight the listing and press <b>Select</b>.</li> <li>3. Press <b>Dial</b>. (You may need to press the <b>more</b> softkey to see <b>Dial</b>.)</li> <li>4. Enter the participant's phone number.</li> <li>5. Highlight the number that you want to dial and press <b>OK</b>.</li> <li>6. Press <b>OK</b> again to dial the number.</li> </ol>
Delete a PAB entry	<ol style="list-style-type: none"> <li>1. Search for a listing.</li> <li>2. Highlight the listing and press <b>Select</b>.</li> <li>3. Press <b>Delete</b>.</li> <li>4. Choose <b>OK</b> to confirm the deletion.</li> </ol>
Edit a PAB entry	<ol style="list-style-type: none"> <li>1. Search for a listing.</li> <li>2. Highlight the listing and press <b>Edit</b> to modify a name or email address.</li> <li>3. If necessary, choose <b>Phones</b> to modify a phone number.</li> <li>4. Press <b>Update</b>.</li> </ol>

If you want to...	Then...
Add a new PAB entry	<ol style="list-style-type: none"> <li>1. Access Personal Directory, then choose <b>Personal Address Book</b>.</li> <li>2. Access the Search page by choosing <b>Submit</b>. (You do not need to input search information first.)</li> <li>3. Press <b>New</b>.</li> <li>4. Use your phone keypad to enter a name and e-mail information.</li> <li>5. Choose <b>Phones</b> and use the keypad to enter phone numbers. Be sure to include any necessary access codes such as a 9 or 1.</li> <li>6. Choose <b>Submit</b> to add the entry to the database.</li> </ol>
Assign a Fast Dial code to a PAB entry	<ol style="list-style-type: none"> <li>1. Search for a PAB entry.</li> <li>2. Highlight the listing and press <b>Select</b>.</li> <li>3. Press <b>Fast Dial</b>.</li> <li>4. Highlight the number that you want to dial and press <b>Select</b>.</li> <li>5. Highlight the Fast Dial code that you want to assign to the number and press <b>Select</b>.</li> </ol>
Add a new Fast Dial code (not using a PAB entry)	<ol style="list-style-type: none"> <li>1. Choose  &gt; <b>Personal Directory</b> &gt; <b>Personal Fast Dials</b>.</li> <li>2. Press <b>Fast Dial</b>.</li> <li>3. Highlight a Fast Dial code that is unassigned and press <b>Select</b>.</li> <li>4. Press <b>Assign</b>.</li> <li>5. Enter a phone number.</li> <li>6. Press <b>Update</b>.</li> </ol>
Search for Fast Dial codes	<ol style="list-style-type: none"> <li>1. Choose  &gt; <b>Personal Directory</b> &gt; <b>Personal Fast Dials</b>.</li> <li>2. You can choose <b>Previous</b> or <b>Next</b> to move through listings.</li> <li>3. Highlight the listing that you want and press <b>Select</b>.</li> </ol>
Place a call using a Fast Dial code	<ol style="list-style-type: none"> <li>1. Search for a Fast Dial code.</li> <li>2. Highlight the listing you want and press <b>Select</b>.</li> <li>3. Press <b>Dial</b>.</li> <li>4. Choose <b>OK</b> to complete the action.</li> </ol>
Delete a Fast Dial code	<ol style="list-style-type: none"> <li>1. Search for a Fast Dial code.</li> <li>2. Highlight the listing you want and press <b>Select</b>.</li> <li>3. Press <b>Remove</b>.</li> </ol>
Log out of Personal Directory	<ol style="list-style-type: none"> <li>1. Choose  &gt; <b>Personal Directory</b> (exact name can vary).</li> <li>2. Choose <b>Logout</b>.</li> </ol>

**Tips**



- Your system administrator can provide you with the user ID and PIN that you need to log in to Personal Directory.
- Personal Directory automatically logs you out after a certain amount of time. This time limit can vary. Ask your system administrator for more information.
- Use the numbers on your keypad to enter characters on your phone screen. Use the Navigation button on your phone to move between input fields.

# Accessing Voice Messages

To access voice messages, use the  button.



**Note** Your company determines the voice message service that your phone system uses. For the most accurate and detailed information, refer to the documentation that came with your voice message system.

If you want to...	Then...
Set up and personalize your voice message service	Press  and follow the voice instructions. If a menu appears on your screen, choose an appropriate menu item.
See if you have a new voice message	Look for: <ul style="list-style-type: none"><li>• A steady red light on your handset. (This indicator can vary. See <a href="#">Customizing Rings and Message Indicators, page 39.</a>)</li><li>• A flashing message waiting icon  and text message on your screen.</li></ul>
Listen to your voice messages or access the voice messages menu	Press  . Depending on your voice message service, doing so either auto-dials the message service or provides a menu on your screen.
Send a call to a voice messaging system	Press <b>iDivert</b> . For more information, see <a href="#">Sending a Call to a Voice Messaging System, page 22.</a>



# Customizing Your Phone on the Web

Your Cisco Unified IP Phone is a network device that can share information with other network devices in your company, including your personal computer. You can use your computer to log in to your Cisco Unified CallManager User Options web pages, where you can control features, settings, and services for your Cisco Unified IP Phone. For example, you can set up speed-dial buttons from your User Options web pages.

## Accessing Your User Options Web Pages

This section describes how to log in to your User Options web pages.

If you want to...	Then do this...
Log in to your User Options web pages	<ol style="list-style-type: none"> <li>1. Obtain a User Options web page URL, user ID, and default password from your system administrator.</li> <li>2. Open a web browser on your computer, enter the URL, and log on.</li> <li>3. If prompted to accept security settings, click <b>Yes</b> or <b>Install Certificate</b>.</li> </ol> <p>The Cisco Unified CallManager User Options main web page displays. From this page you can choose <b>User Options</b> to access User Settings, Directory features, a Personal Address Book, and Fast Dials.</p> <p>Or, to access phone-specific options, select a device (see below).</p>
Select a device after logging in	<ol style="list-style-type: none"> <li>1. After you have logged in to your User Options web pages, choose <b>User Options &gt; Device</b>.</li> </ol> <p>The Device Configuration page displays.</p> <ol style="list-style-type: none"> <li>2. If you have multiple devices assigned to you, verify that the appropriate device (phone model or Extension Mobility profile) is selected. If necessary, choose another device from the Name drop-down menu.</li> </ol> <p>From the Device Configuration page, you can access all of the various configuration options available for your phone (other pages might not provide access to all options).</p> <ul style="list-style-type: none"> <li>– Choose <b>User Options</b> to access User Settings, Directory, Personal Address Book, and Fast Dials.</li> <li>– Choose toolbar buttons to access phone-specific options, such as line settings, phone service settings, and speed dials.</li> </ul> <p>To return to the Device Configuration page from another page, choose <b>User Options &gt; Device</b>.</p>

# Configuring Features and Services on the Web

The topics in this section describe how to configure features and services from your User Options web pages after logging in. See [Accessing Your User Options Web Pages, page 49](#).

## Using Personal Directory on the Web

The Personal Directory feature set consists of:

- A Personal Address Book (PAB)
- Fast Dials
- The Address Book Synchronization Tool (TABSynch)



---

**Note** You can also access PAB and Fast Dials from your phone. See [Using Personal Directory on Your Phone, page 45](#).

---

## Using Your Personal Address Book on the Web

This section describes how to use your PAB from the User Options web pages.

If you want to...	Then do this after you log in...
Add a new PAB entry	<ol style="list-style-type: none"><li>1. Choose <b>User Options &gt; Personal Address Book</b>.</li><li>2. Click <b>New</b>.</li><li>3. Enter information for the entry.</li><li>4. Click <b>Save</b>.</li></ol>
Search for a PAB entry	<ol style="list-style-type: none"><li>1. Choose <b>User Options &gt; Personal Address Book</b>.</li><li>2. Specify search information and click <b>Find</b>.</li></ol>
Edit a PAB entry	<ol style="list-style-type: none"><li>1. Search for a PAB entry.</li><li>2. Click a name or nickname.</li><li>3. Edit the entry as needed and click <b>Save</b>.</li></ol>
Delete a PAB entry	<ol style="list-style-type: none"><li>1. Search for a PAB entry.</li><li>2. Select one or more entries.</li><li>3. Click <b>Delete Selected</b>.</li></ol>

## Configuring Fast Dials on the Web

This section describes how to assign Fast Dials from your User Options web pages.

If you want to...	Then do this after you log in...
Assign a Fast Dial code to a PAB entry	<ol style="list-style-type: none"> <li>1. Create a PAB entry. See <a href="#">Using Your Personal Address Book on the Web, page 50</a>.</li> <li>2. Choose <b>User Options &gt; Fast Dials</b>.</li> <li>3. Click <b>Add New</b>.</li> <li>4. Change the Fast Dial code, if desired.</li> <li>5. Use the Search Options area to find the appropriate PAB entry.</li> <li>6. Click a phone number in the Search Results area.</li> <li>7. Click <b>Save</b>.</li> </ol>
Assign a Fast Dial code to a phone number (without using a PAB entry)	<ol style="list-style-type: none"> <li>1. Choose <b>User Options &gt; Fast Dials</b>.</li> <li>2. Click <b>Add New</b>.</li> <li>3. Change the Fast Dial code, if desired.</li> <li>4. Enter a phone number.</li> <li>5. Click <b>Save</b>.</li> </ol>
Search for a Fast Dial entry	<ol style="list-style-type: none"> <li>1. Choose <b>User Options &gt; Fast Dials</b>.</li> <li>2. Specify search information and click <b>Find</b>.</li> </ol>
Edit a Fast Dial phone number	<ol style="list-style-type: none"> <li>1. Choose <b>User Options &gt; Fast Dials</b>.</li> <li>2. Search for the Fast Dial entry that you want to edit.</li> <li>3. Click on a component of the entry.</li> <li>4. Change the phone number.</li> <li>5. Click <b>Save</b>.</li> </ol>
Delete a Fast Dial entry	<ol style="list-style-type: none"> <li>1. Search for a Fast Dial.</li> <li>2. Select one or more entries.</li> <li>3. Click <b>Delete Selected</b>.</li> </ol>

### Tips

- You can create up to 500 Fast Dial and PAB entries.
- You can create a new Fast Dial entry without using a PAB entry. Such Fast Dial entries are labeled “raw” in the User Options web pages and do not display a configurable text label.

## Using the Address Book Synchronization Tool

You can use the Address Book Synchronization Tool (TABSynch) to synchronize your existing Microsoft Windows Address Book (if applicable) with your PAB. Entries from your Microsoft Windows Address Book will then be accessible on your Cisco Unified IP Phone and User Options web pages. Your system administrator can give you access to TABSynch and provide detailed instructions.

## Setting Up Speed Dials on the Web

Depending on configuration, your phone can support several speed-dial features:

- Speed-dial buttons
- Abbreviated Dialing
- Fast Dials



**Note** For help using speed-dial features, see [Speed Dialing, page 29](#).



If you want to...	Then do this after you log in...
Set up speed-dial buttons	<ol style="list-style-type: none"><li>1. Select a device.</li><li>2. Click <b>Speed Dials</b>.</li><li>3. Enter a number and label for a speed-dial button (programmable button) on your phone.</li><li>4. Click <b>Save</b>.</li></ol> <p><b>Note</b> Your phone uses the ASCII Label field if the phone does not support double-byte character sets.</p>
Set up Abbreviated dialing	<ol style="list-style-type: none"><li>1. Select a device.</li><li>2. Click <b>Speed Dials</b>.</li><li>3. Enter a number and label for an Abbreviated Dialing code.</li><li>4. Click <b>Save</b>.</li></ol>
Set up Fast Dials	See <a href="#">Configuring Fast Dials on the Web, page 51</a> . You can also set up Fast Dials on your phone. See <a href="#">Using Personal Directory on Your Phone, page 45</a> .

### Tip

You can set up a speed-dial button for each programmable button on your phone that is not reserved as a line button. Alternately, use Abbreviated Dial or Fast Dial.

## Setting Up Phone Services on the Web

Phone services can include special phone features, network data, and web-based information (such as stock quotes and movie listings). You must first subscribe to a phone service before accessing it on your phone.

If you want to...	Then do this after you log in and select a device...
Subscribe to a service	<ol style="list-style-type: none"> <li>1. Select a device.</li> <li>2. Click <b>Phone Services</b>.</li> <li>3. Click <b>Add New</b>.</li> <li>4. Choose a service from the drop-down list and click <b>Next</b>.</li> <li>5. Change the service label and/or enter additional service information, if available (optional).</li> <li>6. Click <b>Save</b>.</li> </ol>
Search for services	<ol style="list-style-type: none"> <li>1. Select a device.</li> <li>2. Click <b>Phone Services</b>.</li> <li>3. Click <b>Find</b>.</li> </ol>
Change or end services	<ol style="list-style-type: none"> <li>1. Search for services.</li> <li>2. Select one or more entries.</li> <li>3. Click <b>Delete Selected</b>.</li> </ol>
Change a service name	<ol style="list-style-type: none"> <li>1. Search for services.</li> <li>2. Click on the service name.</li> <li>3. Change the information and click <b>Save</b>.</li> </ol>
Add a service to an available programmable phone button 	<ol style="list-style-type: none"> <li>1. Select a device.</li> <li>2. Click <b>Service URL</b>.</li> </ol> <p><b>Note</b> If you do not see this option, ask your system administrator to configure a service URL button for your phone.</p> <ol style="list-style-type: none"> <li>3. Choose a service from the Button Service drop-down list.</li> <li>4. If you want to rename the service, edit the label fields.</li> </ol> <p><b>Note</b> Your phone uses the ASCII Label field if the phone does not support double-byte character sets.</p> <ol style="list-style-type: none"> <li>5. Click <b>Save</b>.</li> <li>6. Click <b>Reset</b> to reset your phone (necessary to see the new button label on your phone).</li> </ol>
Access a service on your phone	Press  on your phone. Or, if you have added a service to a programmable button  , press the button.

## Controlling User Settings on the Web

User settings include your password, PIN, and language (locale) settings.

<b>If you want to...</b>	<b>Then do this after you log in...</b>
Change your password	<ol style="list-style-type: none"><li>1. Choose <b>User Options &gt; User Settings</b>.</li><li>2. In the Browser Password area, enter information.</li><li>3. Click <b>Save</b>.</li></ol>
Change your PIN	<ol style="list-style-type: none"><li>1. Choose <b>User Options &gt; User Settings</b>.</li><li>2. In the Phone PIN area, enter information.</li><li>3. Click <b>Save</b>.</li></ol>
Change the language (locale) for your User Options web pages	<ol style="list-style-type: none"><li>1. Choose <b>User Options &gt; User Settings</b>.</li><li>2. In the User Locale area of the User Settings page, choose an item from the Locale drop-down list.</li><li>3. Click <b>Save</b>.</li></ol>
Change the language (locale) for your phone screen	<ol style="list-style-type: none"><li>1. Go to the Device Configuration page by choosing <b>User Options &gt; Device</b>.</li><li>2. Choose an item from the User Locale drop-down list.</li><li>3. Click <b>Save</b>.</li></ol>

### Tip

Your PIN and password allow you to access different features and services. For example, use your PIN to log in to Cisco Extension Mobility or Personal Directory on your phone. Use your password to log in to your User Options web pages and Cisco WebDialer on your personal computer. For more information, ask your system administrator.

## Controlling Line Settings on the Web

Line settings affect a specific phone line (directory number) on your phone. Line settings can include call forwarding, voice message indicators, ring patterns, and line labels.



### Note

- You can also set up call forwarding (for your primary phone line) directly on your phone. See [Forwarding All Calls to Another Number, page 23](#).
- To learn about phone settings that you can access directly on your phone, see [Using Phone Settings, page 39](#).

If you want to...	Then do this after you log in...
Set up call forwarding per line	<ol style="list-style-type: none"> <li>1. Select a device.</li> <li>2. Click <b>Line Settings</b>.</li> <li>3. If you have more than one directory number (line) assigned to your phone, verify that the appropriate line is selected or choose a new one.</li> <li>4. In the Incoming Call Forwarding area, choose call forwarding settings for various conditions.</li> <li>5. Click <b>Save</b>.</li> </ol>
Change the voice message indicator setting per line	<ol style="list-style-type: none"> <li>1. Select a device.</li> <li>2. Click <b>Line Settings</b>.</li> <li>3. If you have more than one directory number (line) assigned to your phone, verify that the appropriate line is selected or choose a new one.</li> <li>4. In the Message Waiting Lamp area, choose from various settings.</li> </ol> <p><b>Note</b> Typically, the default message waiting setting prompts your phone to display a steady red light from the handset light strip to indicate a new voice message.</p> <ol style="list-style-type: none"> <li>5. Click <b>Save</b>.</li> </ol>

If you want to...	Then do this after you log in...
Change the ring pattern per line	<ol style="list-style-type: none"> <li>1. Select a device.</li> <li>2. Click <b>Line Settings</b>.</li> <li>3. If you have more than one directory number (line) assigned to your phone, verify that the appropriate line is selected or choose a new one.</li> <li>4. In the Ring Settings area, choose a setting to tell your phone how to indicate an incoming call on the selected line.</li> <li>5. Click <b>Save</b>.</li> </ol> <p><b>Note</b> The “idle” ring setting pertains if you receive an incoming call when the phone is idle. The “consecutive” ring setting pertains if you receive an incoming call when the phone is active.</p>
Change or create a line text label that appears on your phone screen	<ol style="list-style-type: none"> <li>1. Select a device.</li> <li>2. Click <b>Line Settings</b>.</li> <li>3. If you have more than one directory number (line) assigned to your phone, verify that the appropriate line is selected or choose a new one.</li> <li>4. In the Line Text Label area, enter a text label.</li> <li>5. Click <b>Save</b>.</li> </ol> <p><b>Note</b> Your phone uses the ASCII Label field if the phone does not support double-byte character sets.</p>



## Using Cisco WebDialer

Cisco WebDialer allows you to make calls on your Cisco Unified IP Phone to directory contacts by clicking items in a web browser. Your system administrator must configure this feature for you.

If you want to...	Then...
Use WebDialer with your User Options directory	<ol style="list-style-type: none"> <li>1. Log into your User Options web pages. See <a href="#">Accessing Your User Options Web Pages, page 49</a>.</li> <li>2. Choose <b>User Options &gt; Directory</b> and search for a coworker.</li> <li>3. Click the number that you want to dial.</li> <li>4. If this is your first time using WebDialer, set up preferences and click <b>Submit</b>. (See the last row in this table for details.)</li> <li>5. If the Make Call page appears, click <b>Dial</b>. (See the last row in this table to learn how to suppress this page in the future, if desired.) The call is now placed on your phone.</li> <li>6. To end a call, click <b>Hangup</b> or hang up from your phone.</li> </ol>
Use WebDialer with another online corporate directory (not your User Options directory)	<ol style="list-style-type: none"> <li>1. Log into a WebDialer-enabled corporate directory and search for coworkers.</li> <li>2. Click the number that you want to dial.</li> <li>3. When prompted, enter your user ID and password.</li> <li>4. If this is your first time using WebDialer, set up preferences and click <b>Submit</b>. (See the last row in this table for details.)</li> <li>5. If the Make Call page appears, click <b>Dial</b>. (See the last row in this table to learn how to suppress this page in the future, if desired.) The call is now placed on your phone.</li> <li>6. To end a call, click <b>Hangup</b> or hang up from your phone.</li> </ol>

If you want to...	Then...
Log out of WebDialer	Click the logout icon in the Make Call or Hang Up page.
Set up, view, or change WebDialer preferences	<p data-bbox="341 232 663 264">Access the Preferences page.</p> <p data-bbox="341 274 1208 334">The Preferences page appears the first time that you use WebDialer (after you click the number that you want to dial.)</p> <p data-bbox="341 344 1174 406">To return to Preferences in the future, click the preferences icon from the Make Call or Hang Up page.</p> <p data-bbox="341 415 944 448">The Preferences page contains the following options:</p> <ul data-bbox="354 457 1208 915" style="list-style-type: none"> <li data-bbox="354 457 1139 519">• Preferred language—Determines the language used for WebDialer settings and prompts.</li> <li data-bbox="354 529 1208 716">• Use permanent device—Identifies the Cisco Unified IP Phone and directory number (line) that you will use to place WebDialer calls. If you have one phone with a single line, the appropriate phone and line are automatically selected. Otherwise, choose a phone and/or line. Phones are specified by host name. (To display the host name on the phone, choose  &gt; <b>Network Configuration</b> &gt; <b>Host Name</b>.)</li> <li data-bbox="354 725 1204 816">• Use Extension Mobility—If selected, prompts WebDialer to use the Cisco Unified IP Phone that is associated with your Extension Mobility profile (if available).</li> <li data-bbox="354 826 1208 915">• Do not display call confirmation—If selected, prompts WebDialer to suppress the Make Call page. This page appears by default after you click a phone number in a WebDialer-enabled online directory.</li> </ul>

# Understanding Additional Configuration Options

Your system administrator can configure your phone to use specific button and softkey templates along with special services and features, if appropriate. This table provides an overview of some configuration options that you might want to discuss with your phone system administrator based on your calling needs or work environment.



**Note** You can locate Phone Guides and other documents listed in this table on the web:  
[http://www.cisco.com/univercd/cc/td/doc/product/voice/c\\_ipphon/index.htm](http://www.cisco.com/univercd/cc/td/doc/product/voice/c_ipphon/index.htm)

If you...	Then...	For more information...
Need to handle more calls on your phone line	Ask your system administrator to configure your line to support more calls.	Talk to your system administrator or phone support team.
Need more than one phone line	Ask your system administrator to configure one or more additional directory numbers for you.	Talk to your system administrator or phone support team.
Need more speed-dial buttons	First make sure that you are using all of your currently available speed-dial buttons.  If you need additional speed-dial buttons, try using Abbreviated Dialing or subscribing to the Fast Dial service.  Another option is to attach the Cisco Unified IP Phone Expansion Module 7914 to your phone.	See: <ul style="list-style-type: none"> <li>• <a href="#">Speed Dialing, page 29</a></li> <li>• <i>Cisco Unified IP Phone Expansion Module 7914 Phone Guide</i> (SCCP phones only)</li> </ul>
Work with (or work as) an administrative assistant (SCCP phones only)	Consider using: <ul style="list-style-type: none"> <li>• Cisco Unified CallManager Assistant</li> <li>• A shared line</li> </ul>	See: <ul style="list-style-type: none"> <li>• <a href="#">Using a Shared Line, page 31</a></li> <li>• <i>Cisco Unified CallManager Assistant User Guide</i></li> </ul>
Want to use one extension for several phones	Request a shared line. This allows you to use one extension for your desk phone and lab phone, for example.	See <a href="#">Using a Shared Line, page 31</a> .

If you...	Then...	For more information...
Share phones or office space with coworkers	Consider using: <ul style="list-style-type: none"> <li>• Call Park to store and retrieve calls without using the transfer feature</li> <li>• Call Pickup to answer calls ringing on another phone</li> <li>• A shared line to view or join coworkers' calls</li> <li>• Cisco Extension Mobility to apply your phone number and user profile to a shared Cisco Unified IP Phone</li> </ul>	Ask your system administrator about these features and see: <ul style="list-style-type: none"> <li>• <a href="#">Advanced Call Handling, page 29</a></li> <li>• <a href="#">Using a Shared Line, page 31</a></li> <li>• <a href="#">Using Cisco Extension Mobility, page 36</a></li> </ul>
Answer calls frequently or handle calls on someone's behalf	Ask your system administrator to set up the AutoAnswer feature for your phone.	See <a href="#">Using AutoAnswer, page 38</a> .
Need to make video calls (SCCP phones only)	Consider using Cisco Unified Video Advantage, which enables you to make video calls using your Cisco IP Phone, your personal computer, and an external video camera.	Contact your system administrator for additional assistance and see the <i>Cisco Unified Video Advantage Quick Start Guide</i> and <i>User Guide</i> .
Determine the state of a phone line associated with a speed-dial button, call log, or directory listing on your phone	Ask your administrator to set up the Busy Lamp Field (BLF) feature for your phone.	See <a href="#">Using BLF to Determine a Line State, page 36</a> .
Want to temporarily apply your phone number and settings to a shared Cisco Unified IP Phone	Ask your system administrator about the Cisco Extension Mobility Service.	See <a href="#">Using Cisco Extension Mobility, page 36</a> .

# Troubleshooting Your Phone

This section provides information to help you troubleshoot problems with your phone.





## General Troubleshooting

This section provides information to help you troubleshoot general problems with your phone. For more information, see your system administrator.

Symptom	Explanation
You cannot hear a dial tone or complete a call	One or more of the following factors might apply: <ul style="list-style-type: none"> <li>You must log into the Extension Mobility service.</li> <li>You must enter a client matter code (CMC) or forced authorization code (FAC) after dialing a number. (SCCP phones only)</li> <li>Your phone has time-of-day restrictions that prevent you from using some features during certain hours of the day.</li> </ul>
The Settings button is unresponsive	Your system administrator might have disabled  on your phone.
The softkey that you want to use does not appear	One or more of the following factors might apply: <ul style="list-style-type: none"> <li>You must press <b>more</b> to reveal additional softkeys.</li> <li>You must change the line state (for example, go off-hook or have a connected call).</li> <li>Your phone is not configured to support the feature associated with that softkey.</li> </ul>
<b>Join</b> fails (SCCP phones only)	<b>Join</b> requires multiple selected calls. Be sure that you have selected at least one call in addition to the active call, which is selected automatically. <b>Join</b> also requires the selected calls to be on the same line. If necessary, transfer calls to one line before joining them.
<b>Barge</b> fails and results in a fast busy tone	You cannot barge an encrypted call if the phone you are using is not configured for encryption. When your barge attempt fails for this reason, your phone plays a fast busy tone.
You are disconnected from a call that you joined using <b>Barge</b>	You will be disconnected from a call that you have joined using <b>Barge</b> if the call is put on hold, transferred, or turned into a conference call.
Cisco CallBack fails	The other party might have call forwarding enabled.

## Viewing Phone Administration Data

Your system administrator might ask you to access administration data on your phone for troubleshooting purposes.

If you are asked to...	Then...
Access network configuration data	Choose  > <b>Network Configuration</b> and select the network configuration item that you want to view.
Access status data	Choose  > <b>Status</b> and select the status item that you want to view.
Access phone model information	Choose  > <b>Model Information</b> .
Access phone call and voice quality information (SCCP phones only)	Choose  > <b>Status &gt; Call Statistics</b> .

## Using the Quality Reporting Tool

Your system administrator may temporarily configure your phone with the Quality Reporting Tool (QRT) to troubleshoot performance problems. You can press **QRT** to submit information to your system administrator. Depending on configuration, use the QRT to:

- Immediately report an audio problem on a current call.
- Select a general problem from a list of categories and choose reason codes.

# Cisco One-Year Limited Hardware Warranty Terms

---

There are special terms applicable to your hardware warranty and various services that you can use during the warranty period. Your formal Warranty Statement, including the warranties and license agreements applicable to Cisco software, is available on Cisco.com. Follow these steps to access and download the *Cisco Information Packet* and your warranty and license agreements from Cisco.com.

1. Launch your browser, and go to this URL:

[http://www.cisco.com/univercd/cc/td/doc/es\\_inpck/cetrans.htm](http://www.cisco.com/univercd/cc/td/doc/es_inpck/cetrans.htm)

The Warranties and License Agreements page appears.

2. To read the *Cisco Information Packet*, follow these steps:
  - a. Click the **Information Packet Number** field, and make sure that the part number 78-5235-03A0 is highlighted.
  - b. Select the language in which you would like to read the document.
  - c. Click **Go**.

The Cisco Limited Warranty and Software License page from the Information Packet appears.

- d. Read the document online, or click the **PDF** icon to download and print the document in Adobe Portable Document Format (PDF).



---

**Note**

You must have Adobe Acrobat Reader to view and print PDF files. You can download the reader from Adobe's website: <http://www.adobe.com>

---

3. To read translated and localized warranty information about your product, follow these steps:
  - a. Enter this part number in the Warranty Document Number field:  
78-10747-01C0
  - b. Select the language in which you would like to view the document.
  - c. Click **Go**.

The Cisco warranty page appears.

- d. Read the document online, or click the **PDF** icon to download and print the document in Adobe Portable Document Format (PDF).

You can also contact the Cisco service and support website for assistance:

[http://www.cisco.com/public/Support\\_root.shtml](http://www.cisco.com/public/Support_root.shtml).

## Duration of Hardware Warranty

One (1) Year

## **Replacement, Repair, or Refund Policy for Hardware**

Cisco or its service center will use commercially reasonable efforts to ship a replacement part within ten (10) working days after receipt of a Return Materials Authorization (RMA) request. Actual delivery times can vary, depending on the customer location.

Cisco reserves the right to refund the purchase price as its exclusive warranty remedy.

### **To Receive a Return Materials Authorization (RMA) Number**

Contact the company from whom you purchased the product. If you purchased the product directly from Cisco, contact your Cisco Sales and Service Representative.

Complete the information below, and keep it for reference.

Company product purchased from	
Company telephone number	
Product model number	
Product serial number	
Maintenance contract number	





## Index

---

### A

- Address Book Synchronization Tool **52**
- answering calls, options for **18**
- ASCII label field support **52, 53**
- audio problems **62**
- audio, quality of **7**
- authenticated calls **34**
- Auto Dial **16**
- AutoAnswer **38**

### B

- barge
  - and privacy **33**
  - and shared lines **31**
  - using **32**
- BLF **36**
- Busy Lamp Field
  - see BLF **36**

### C

- call activity area, viewing **12**
- call forwarding **23**
- call logs
  - dialing from a URL entry in **42**
  - erasing **41**

- viewing and dialing from **41**
- call park **33**
- call pickup, using **30**
- call waiting **18**
- caller ID **12**
- call-handling, advanced **29**
- call-handling, basic **16**
- calls
  - answering **18**
  - barging **32**
  - blocking **24**
  - compared to lines **14**
  - conference features for **25**
  - ending **19**
  - forwarding **23**
  - handling multiple **20**
  - holding and resuming **19**
  - icons for **14**
  - maximum per line **14**
  - multiple parties on **25**
  - multiple, switching between **20**
  - muting **20**
  - parking **33**
  - placing **16**
  - prioritizing **35**
  - redirecting while ringing **30**
  - reporting problems with **62**

- secure **34**
- storing and retrieving **33**
- transferring **21**
- using DND **24**
- viewing **12, 20**
- viewing multiple **20**
- cBarge **32**
- Cisco Unified IP Phone
  - adjusting height of **6**
  - connecting **5**
  - description of **8**
  - feature configuration for **15, 59**
  - illustration of **9**
  - online help for **13**
  - registering **6**
  - securing handset rest **6**
- Cisco Unified IP Phone Expansion Module 7914 **59**
- Cisco Unified Video Advantage **60**
- Cisco WebDialer
  - See also WebDialer **57**
- Client Matter Code **18**
- CMC **18**
- conference calls
  - Meet-Me **25, 28**
  - standard **25, 26**
- configuration
  - Fast Dials **51**
  - features and services **50**
  - options **59**
- corporate directory
  - dialing from web page with **17**
  - using on phone **17**
- customization

- messages **48**

## **D**

- Details softkey, viewing multiparty calls with **43**
- dialing, options for **16**
- directory
  - corporate **43**
  - dialing from web page with **17**
  - personal **43**
  - using on phone **17, 41**
- DND **24**
- Do Not Disturb **24**

## **E**

- encrypted calls **34**
- ending a call, options for **19**
- Extension Mobility
  - log in **36**
  - log out **36**
- extension numbers, viewing **12**

## **F**

- FAC **18**
- Fast Dial service
  - dialing with **18**
- feature buttons
  - help **10**
  - messages **10**
  - services **10**
  - settings **10**

- feature menus, using **15**
- features, availability of **15, 59**
- footstand
  - adjusting **6**
  - button, identifying **10**
- Forced Authorization Code **18**
- forwarding calls, options for **23**

## **G**

- group call pickup, using **30**

## **H**

- handset
  - light strip **11**
  - securing in cradle **6**
  - using **37**
- hanging up, options for **19**
- headset
  - answering calls with **18**
  - audio quality **7**
  - button, identifying **11**
  - hanging up with **19**
  - mode **37**
  - obtaining **38**
- headset performance, general **7**
- help button, description of **10**
- help, using **13**
- hold
  - and resuming calls **19**
  - and switching calls **20**
  - and transferring **21**

- using **19**

## **I**

- icons
  - for call states **14**
  - for lines **14**
- iDivert
  - description of **2**
- installing, Cisco Unified IP Phone **5**

## **K**

- keypad
  - description of **11**

## **L**

- language (locale) settings **54**
- line buttons, identifying **10**
- lines
  - and call states **14**
  - and using BLF **36**
  - description of **14**
  - icons **14**
  - viewing **12**

## **M**

- Malicious Call Identification (MCID), using **34**
- Meet-Me conferences **25, 28**
- menus, using **15**
- messages

- indicator for **39, 48**
- listening to **48**
- messages button, description of **10**
- missed calls, records of **41**
- MLPP, using **35**
- multiparty calls
  - viewing details of **43**
- multiple calls, handling **20**
- mute button, description of **11**
- mute, using **20**

## **N**

- navigation button, description of **11**
- network configuration data, locating **61**

## **O**

- on-hook dialing **16**
- online help, using **13**

## **P**

- PAB **43**
- Personal Address Book
  - See PAB **45**
- Personal Address Book (PAB)
  - dialing from **18**
- phone lines
  - buttons for **10**
  - description of **14**
  - viewing **12**
- phone screen

- adjusting contrast of **40**
- changing language of **40**
- cleaning **12**
- features of **12**
- phone services
  - See also User Options web pages **53**
- placed calls, records of **41**
- placing calls, options for **16**
- prioritizing calls **35**
- privacy
  - and shared lines **31**
  - using **33**
- programmable buttons
  - description of **10**
  - labels for **12**

## **Q**

- QRT **62**
- QRT, using **62**
- Quality Reporting Tool **62**

## **R**

- received calls, records of **41**
- redial **16**
- Remote-in-Use icon for shared lines **31**
- resume, using **19**
- ringer
  - customizing **39**
  - indicator for **11**

## **S**

- safety, warnings **2**
- secure calls **34**
- security
  - levels of **34**
  - making and receiving secure calls **34**
  - verifying non-secure calls **34**
- services
  - changing or ending **53**
  - service names **53**
  - subscribing to **53**
- services button, description of **10**
- settings button, description of **10**
- shared lines
  - and Remote-in-Use icon **31**
  - description of **31**
  - with barge **32**
  - with privacy **33**
- softkey buttons
  - description of **11**
  - labels for **12**
- sound
  - See audio, quality of **7**
- speakerphone
  - answering calls with **18**
  - button, identifying **11**
  - hanging up with **19**
  - mode **37**
- speed dial **29**
  - buttons, identifying **10**
  - labels **12**
  - using **17**
- status data, locating **61**

- status line, viewing **12**
- subscriptions
  - See services, subscribing to **53**
- suspicious calls, tracing **34**
- switching calls **20**

## **T**

- Tabs, phone and feature **12**
- TABSynch **52**
- TAPS, using **6**
- text, entering on phone **15**
- Tool for Auto-Registered Phones Support **6**
- transferring, options for **21**
- troubleshooting **61**
  - See also QRT **61**

## **U**

- URL dialing, from call log **42**
- User Options web pages
  - subscribing and unsubscribing to phone services **53**

## **V**

- voice message indicator **48**
- voice message service **48**
- volume button, description of **11**

## **W**

- warnings, safety **2**

web-based services

See User Options web pages **53**

WebDialer **17**





**Corporate Headquarters**  
Cisco Systems, Inc.  
170 West Tasman Drive  
San Jose, CA 95134-1706  
USA  
www.cisco.com  
Tel: 408 526-4000  
800 553-NETS (6387)  
Fax: 408 526-4100

**European Headquarters**  
Cisco Systems International BV  
Haarlerbergpark  
Haarlerbergweg 13-19  
1101 CH Amsterdam  
The Netherlands  
www-europe.cisco.com  
Tel: 31 0 20 357 1000  
Fax: 31 0 20 357 1100

**Americas Headquarters**  
Cisco Systems, Inc.  
170 West Tasman Drive  
San Jose, CA 95134-1706  
USA  
www.cisco.com  
Tel: 408 526-7660  
Fax: 408 527-0883

**Asia Pacific Headquarters**  
Cisco Systems, Inc.  
168 Robinson Road  
#28-01 Capital Tower  
Singapore 068912  
www.cisco.com  
Tel: +65 6317 7777  
Fax: +65 6317 7799

Cisco Systems has more than 200 offices in the following countries. Addresses, phone numbers, and fax numbers are listed on the **Cisco Website at [www.cisco.com/go/offices](http://www.cisco.com/go/offices)**

Argentina • Australia • Austria • Belgium • Brazil • Bulgaria • Canada • Chile • China PRC • Colombia • Costa Rica • Croatia • Cyprus • Czech Republic • Denmark • Dubai, UAE  
Finland • France • Germany • Greece • Hong Kong SAR • Hungary • India • Indonesia • Ireland • Israel • Italy • Japan • Korea • Luxembourg • Malaysia • Mexico  
The Netherlands • New Zealand • Norway • Peru • Philippines • Poland • Portugal • Puerto Rico • Romania • Russia • Saudi Arabia • Scotland • Singapore  
Slovakia • Slovenia • South Africa • Spain • Sweden • Switzerland • Taiwan • Thailand • Turkey • Ukraine • United Kingdom • United States • Venezuela • Vietnam • Zimbabwe

CCSP, CCVP, the Cisco Square Bridge logo, Follow Me Browsing, and StackWise are trademarks of Cisco Systems, Inc.; Changing the Way We Work, Live, Play, and Learn, and iQuick Study are service marks of Cisco Systems, Inc.; and Access Registrar, Aironet, BPX, Catalyst, CCDA, CCDP, CCIE, CCIP, CCNA, CCNP, Cisco, the Cisco Certified Internetwork Expert logo, Cisco IOS, Cisco Press, Cisco Systems, Cisco Systems Capital, the Cisco Systems logo, Cisco Unity, Enterprise/Solver, EtherChannel, EtherFast, EtherSwitch, Fast Step, FormShare, GigaDrive, GigaStack, HomeLink, Internet Quotient, IOS, IP/TV, iQ Expertise, the iQ logo, iQ Net Readiness Scorecard, LightStream, Linksys, MeetingPlace, MGX, the Networkers logo, Networking Academy, Network Registrar, *Packet*, PIX, Post-Routing, Pre-Routing, ProConnect, RateMUX, ScriptShare, SlideCast, SMARTnet, The Fastest Way to Increase Your Internet Quotient, and TransPath are registered trademarks of Cisco Systems, Inc. and/or its affiliates in the United States and certain other countries.

All other trademarks mentioned in this document or Website are the property of their respective owners. The use of the word partner does not imply a partnership relationship between Cisco and any other company. (0601R)

© 2006 Cisco Systems, Inc. All rights reserved.



The Java logo is a trademark or registered trademark of Sun Microsystems, Inc. in the U.S. or other countries.